



Ghosts in the Machines

A History of Spirit Communication Devices



MysteriousPlanchette.com



IAPSOP







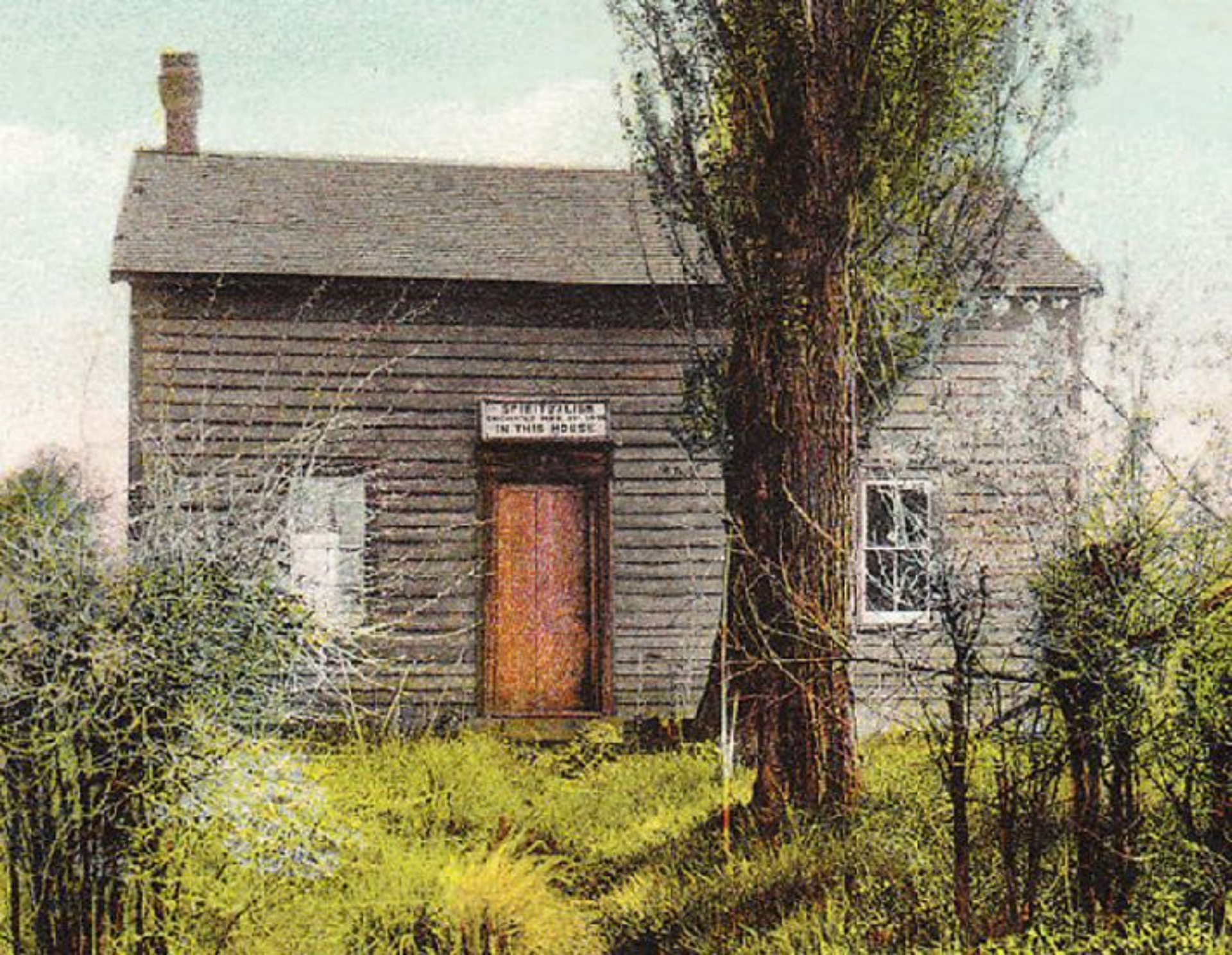

SPIRITUALISM
ENCHANTED MARK OF THE
IN THIS HOUSE

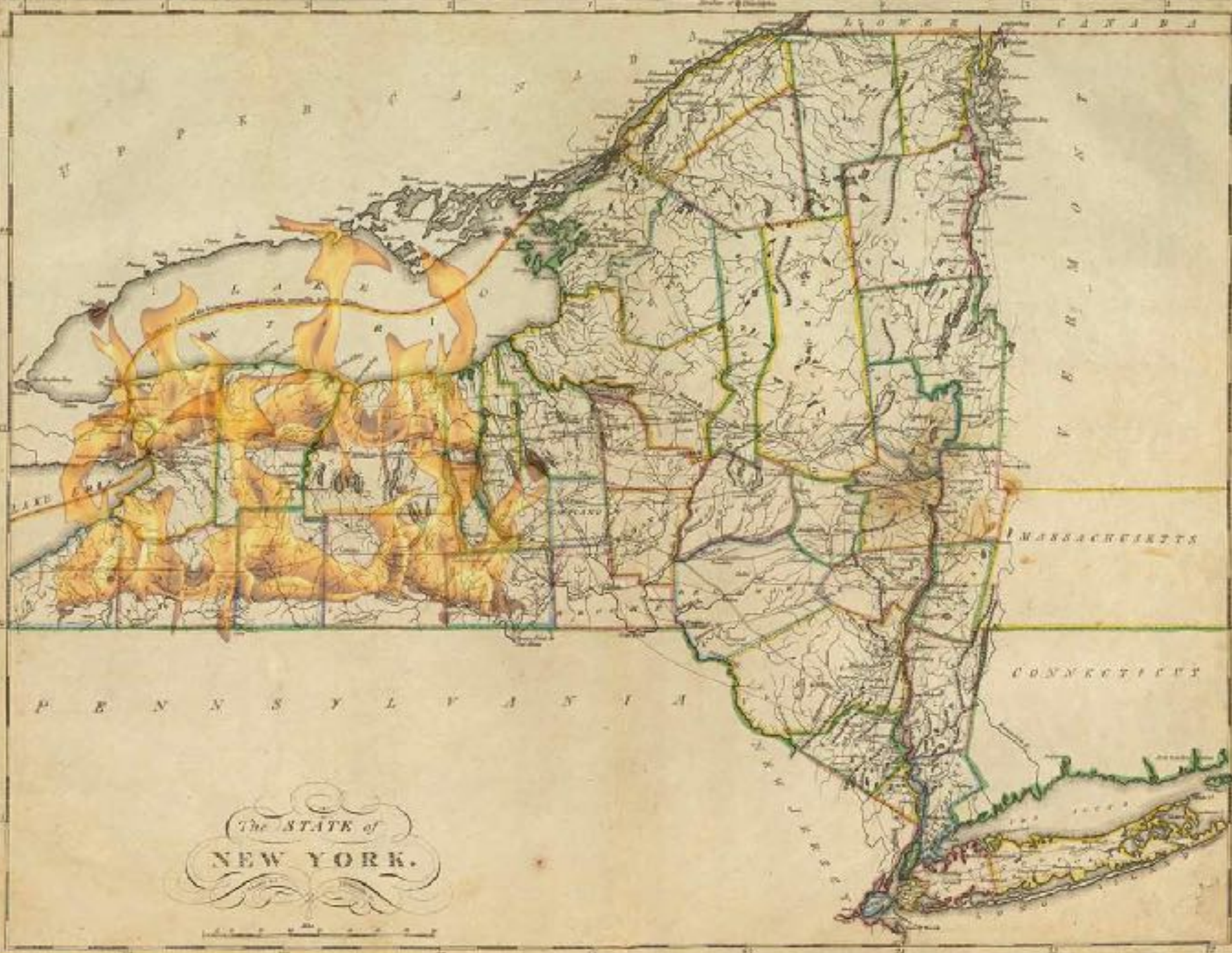

The STATE of
NEW YORK.

Scale of Miles

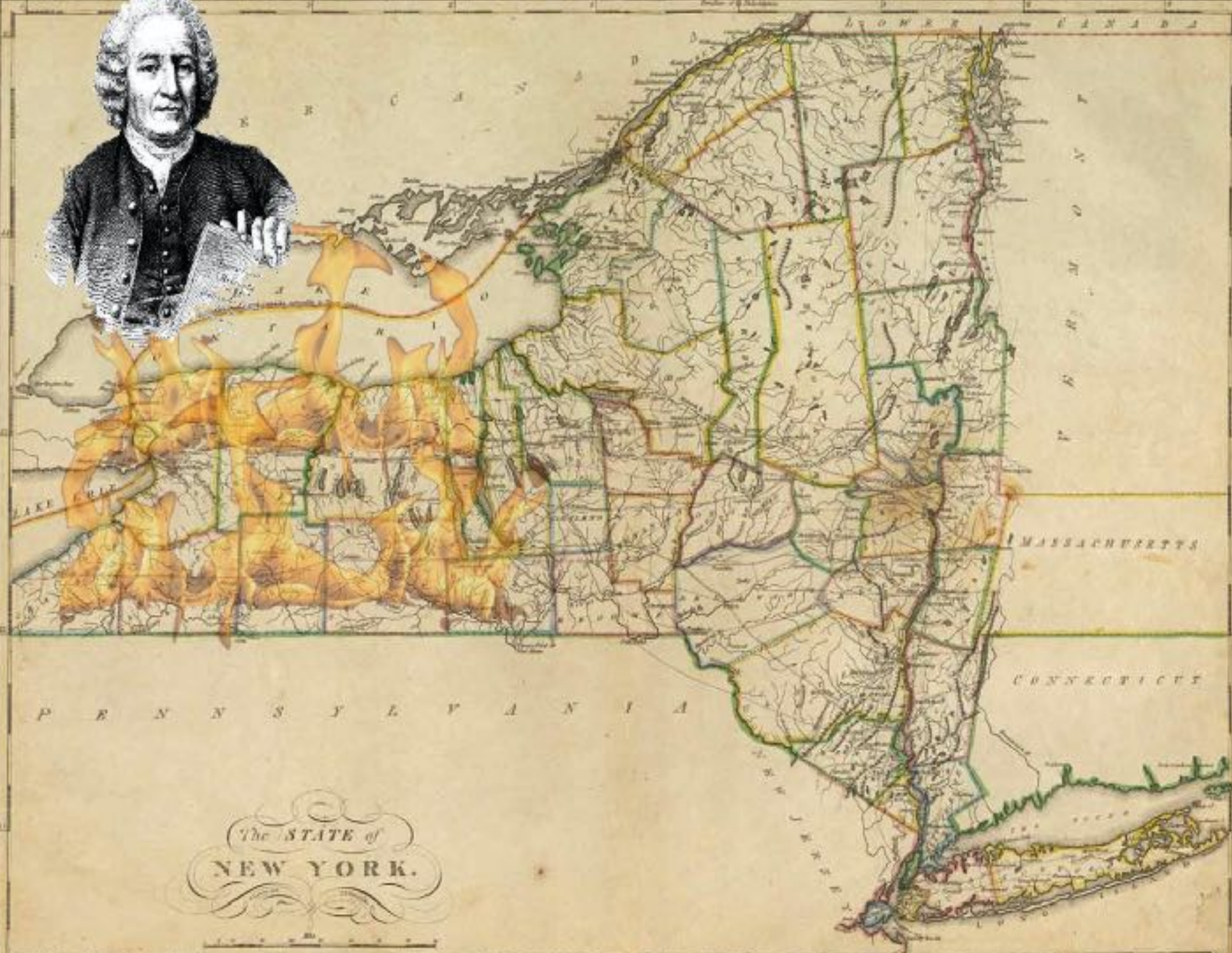

The STATE of
NEW YORK.

P E N N S Y L V A N I A

MASSACHUSETTS

CONNECTICUT

LOWER CANADA

V E R M O N T

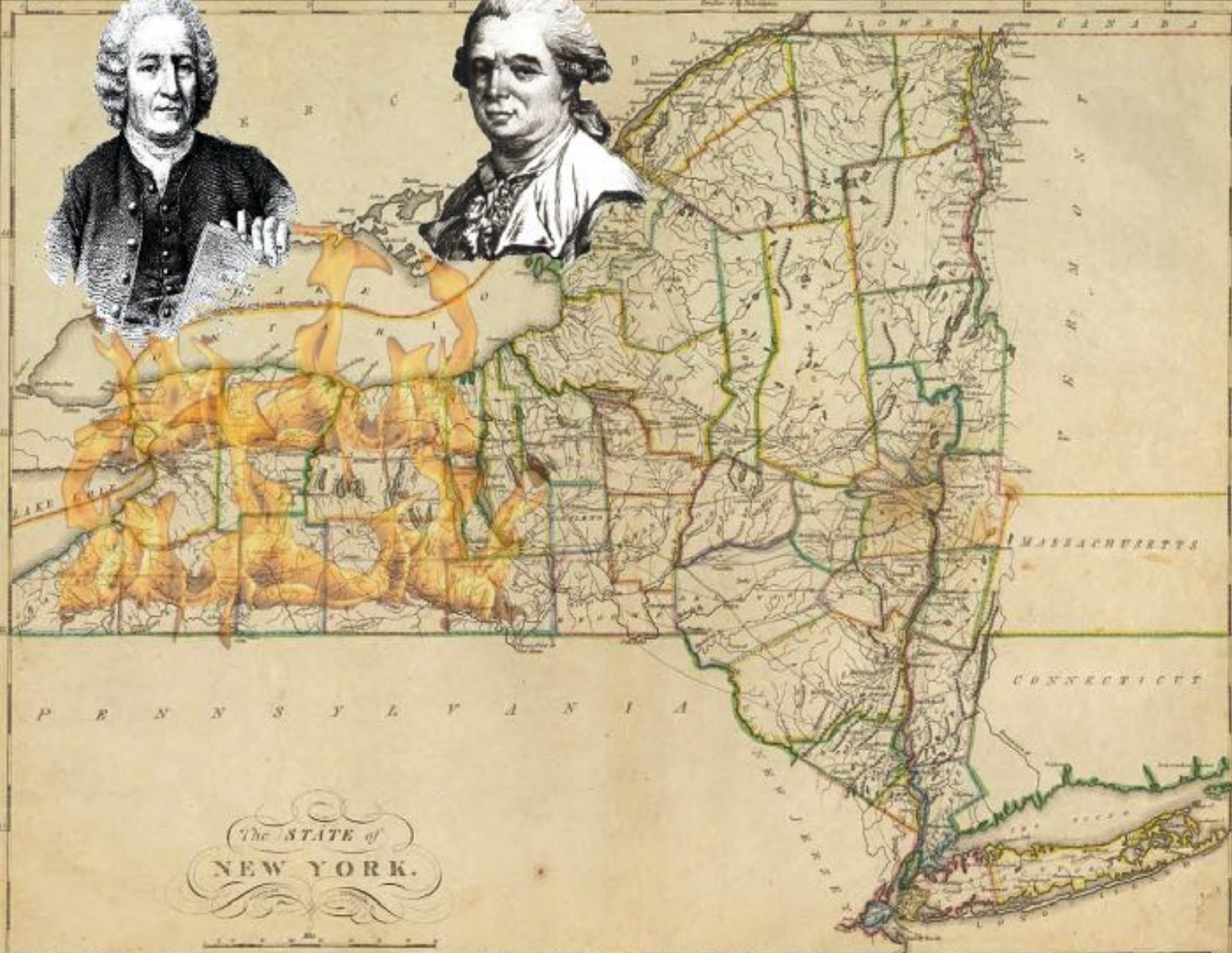

The STATE of
NEW YORK.



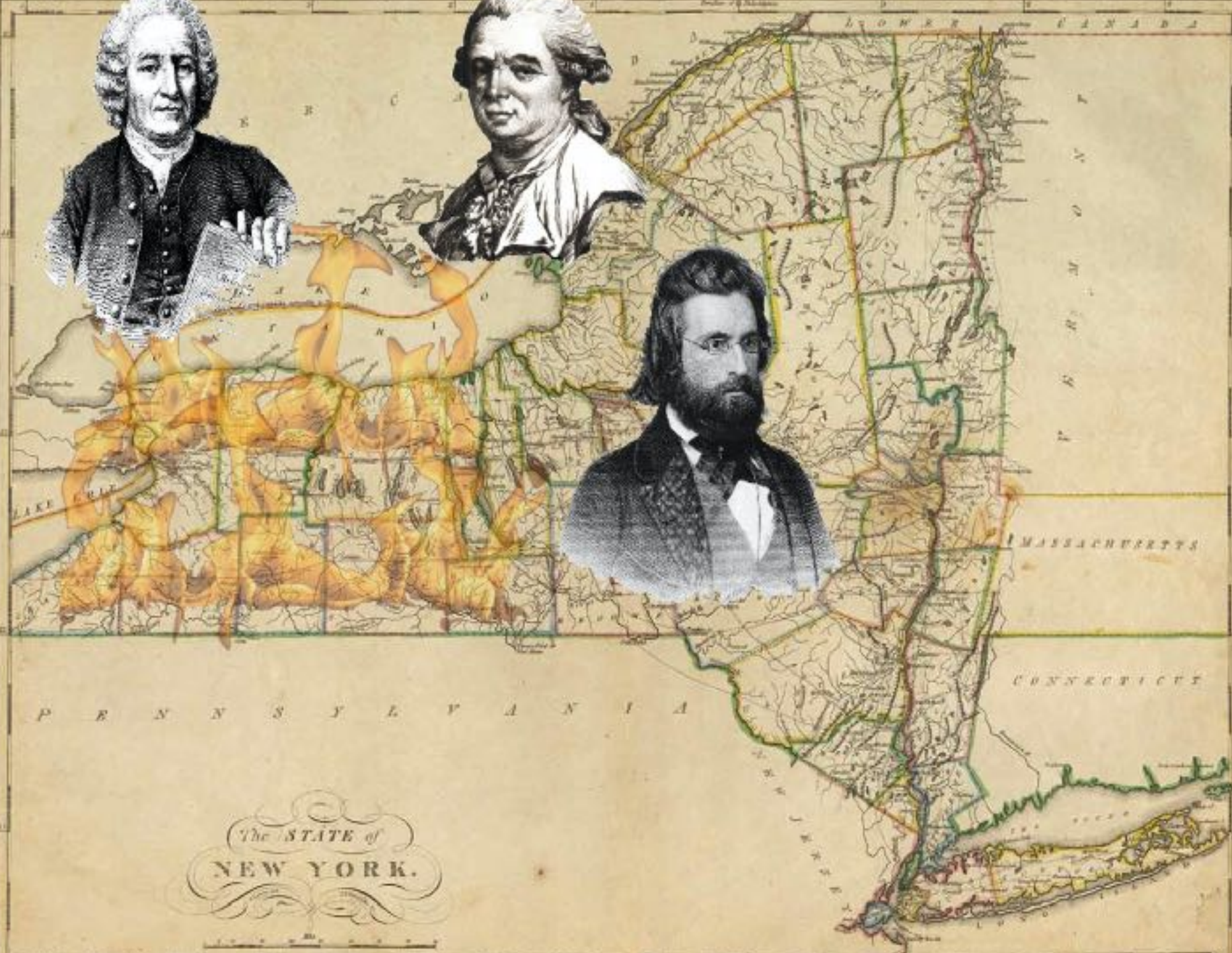

The STATE of
NEW YORK.



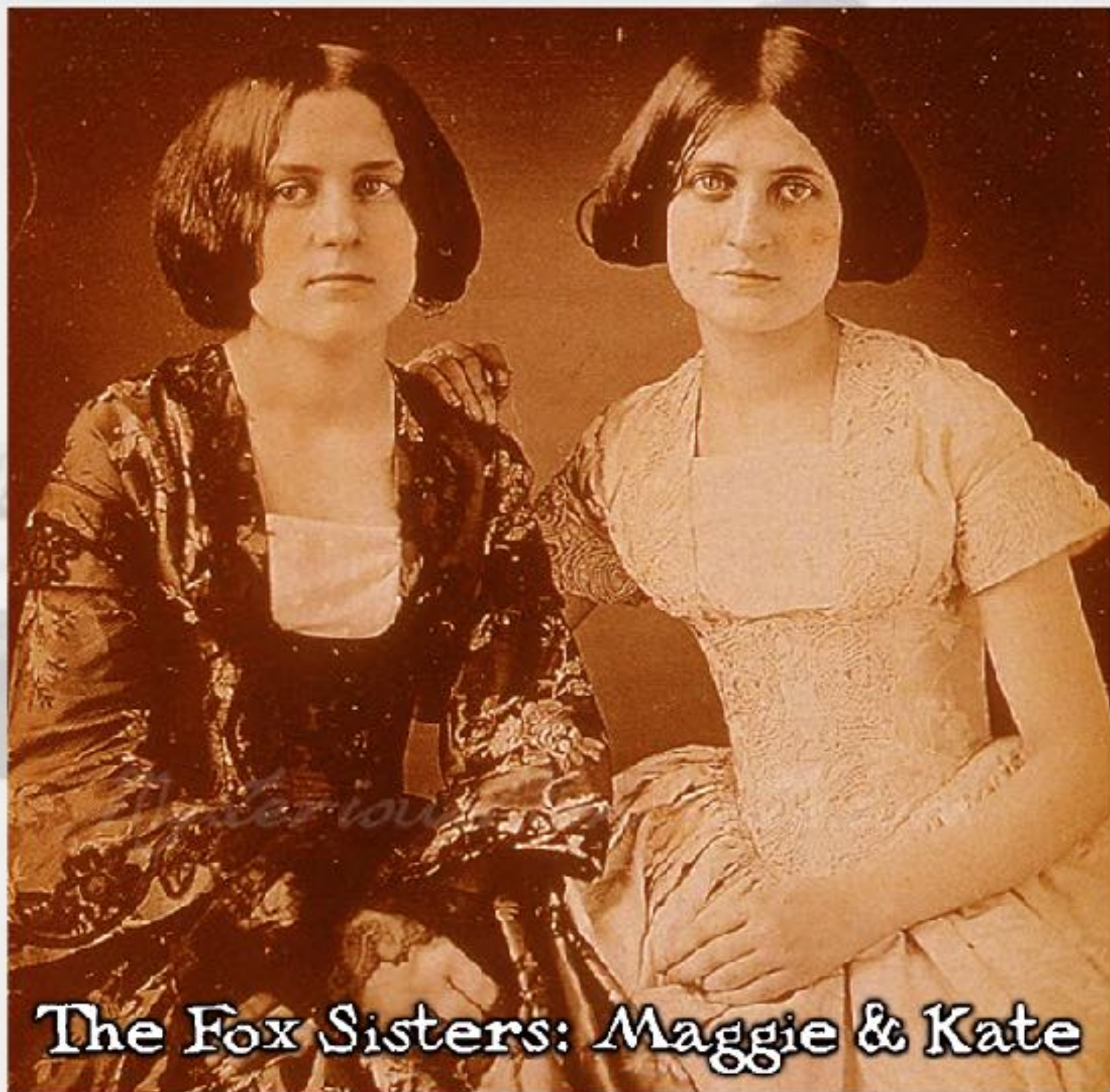

The Fox Sisters: Maggie & Kate

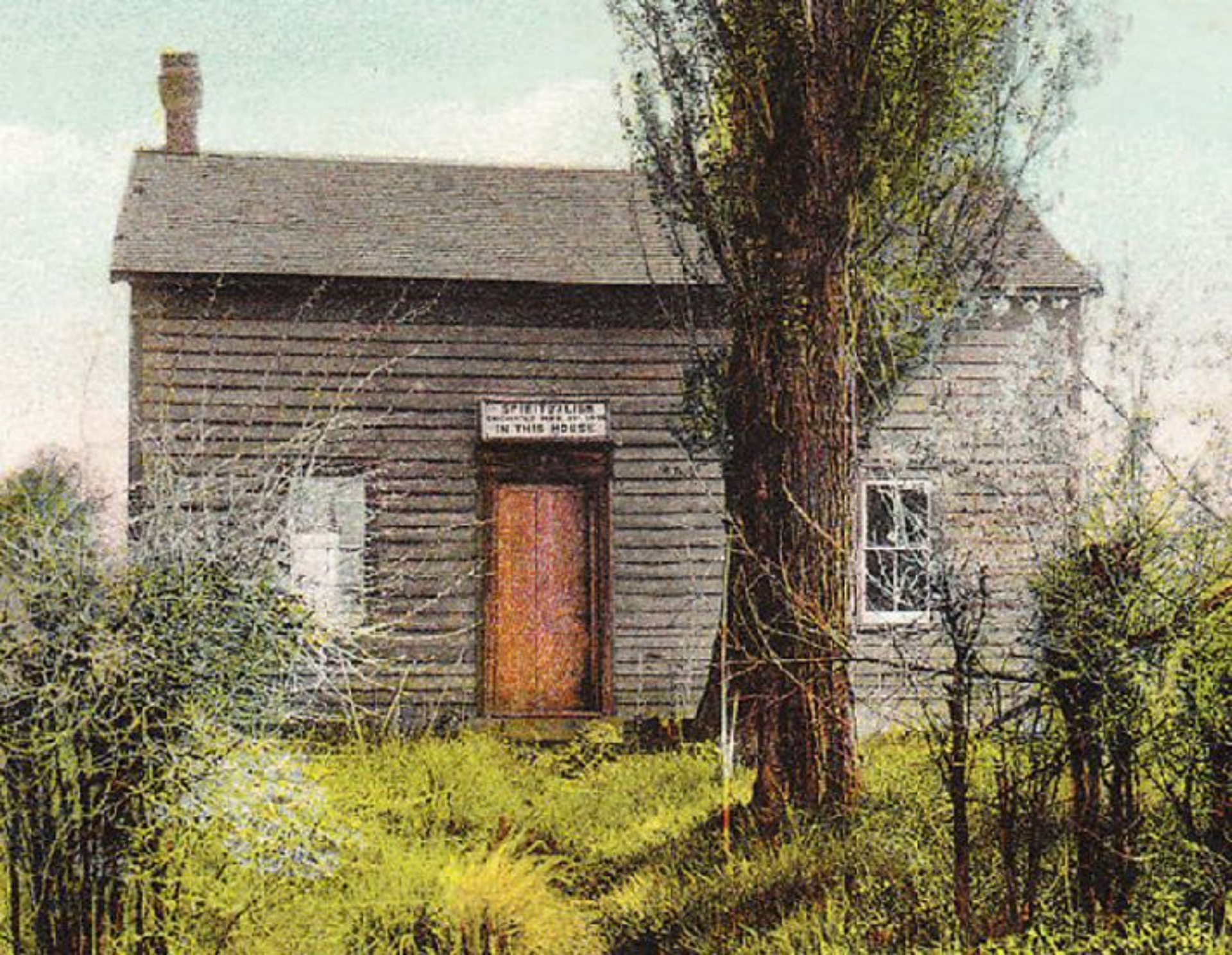

SPIRITUALISM
ENCHANTED MARK OF THE
IN THIS HOUSE

A young child is sitting at a table, wearing goggles and a life preserver. The child is writing on a piece of paper with a pen. The background is a plain, light-colored wall.

A B C

YES

NO

Alphabet Calling



Direct Voice Channeling



Automatic Writing



1853



"TABLE-MOVING."

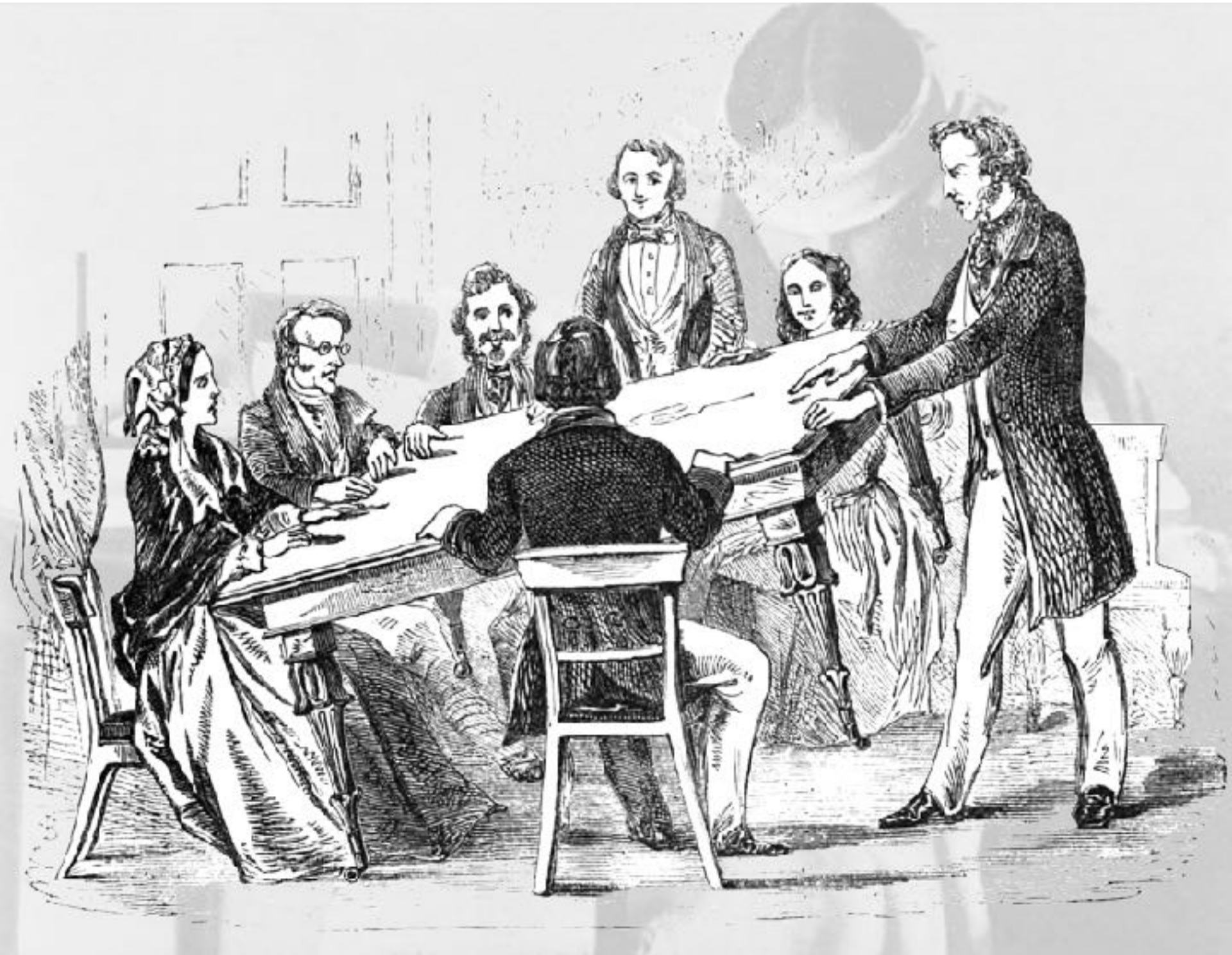



March 23, 1853



Un salon de Paris au mois de mai 1831.





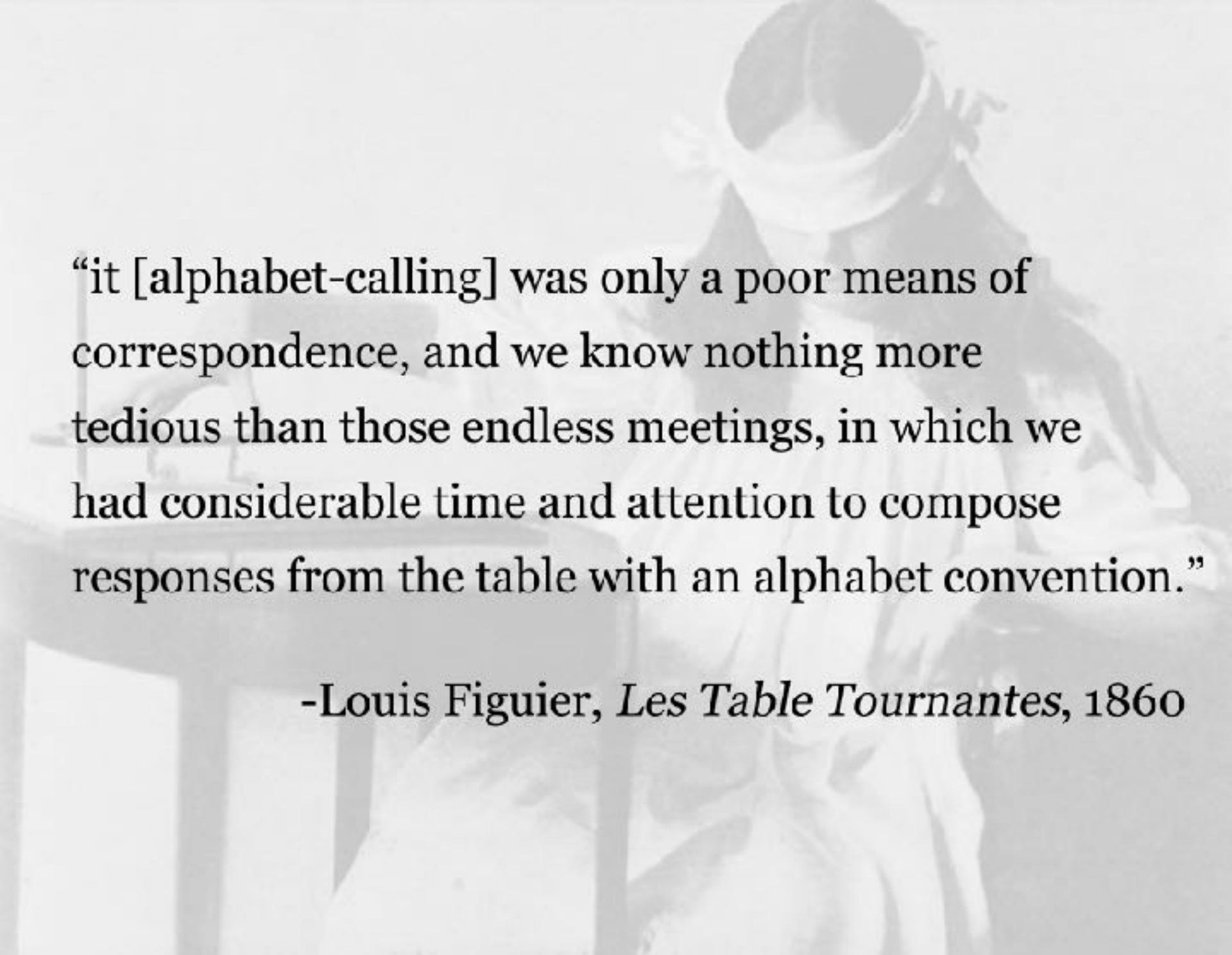

“it [alphabet-calling] was only a poor means of correspondence, and we know nothing more tedious than those endless meetings, in which we had considerable time and attention to compose responses from the table with an alphabet convention.”

-Louis Figuier, *Les Table Tournantes*, 1860

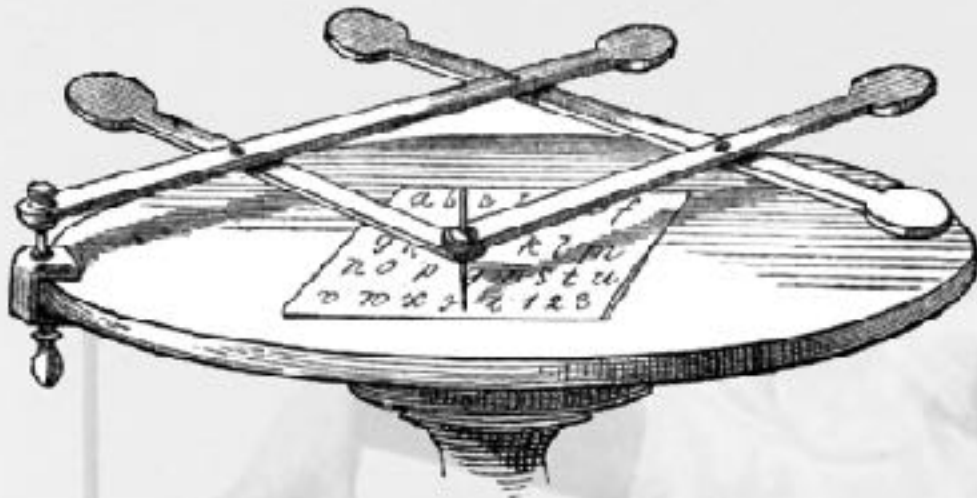

Wagner "Psychograph," 1853

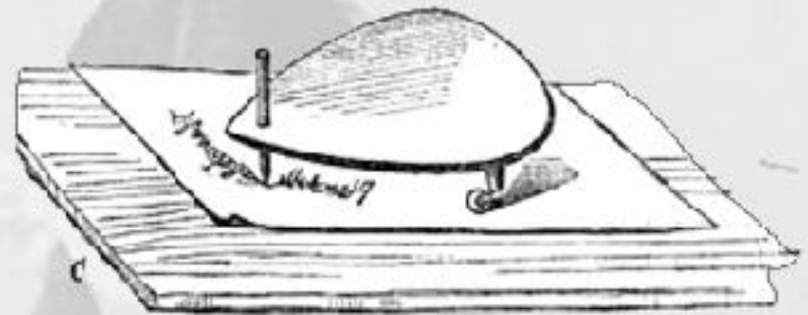

Planchettes, 1853



Pease "Spiritual Telegraph Dial," 1853

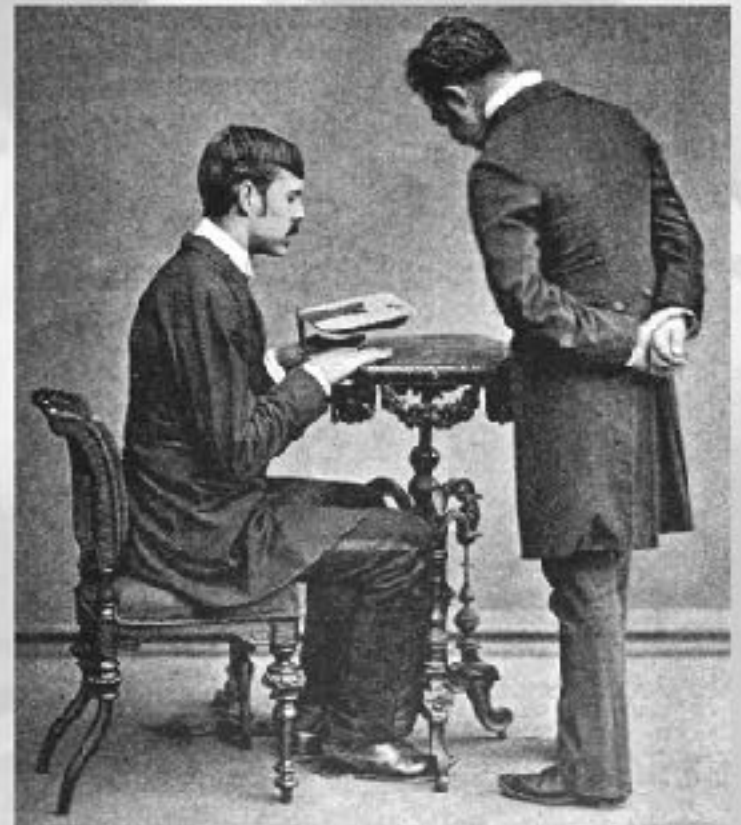

Hornung's "Emanulector," 1854

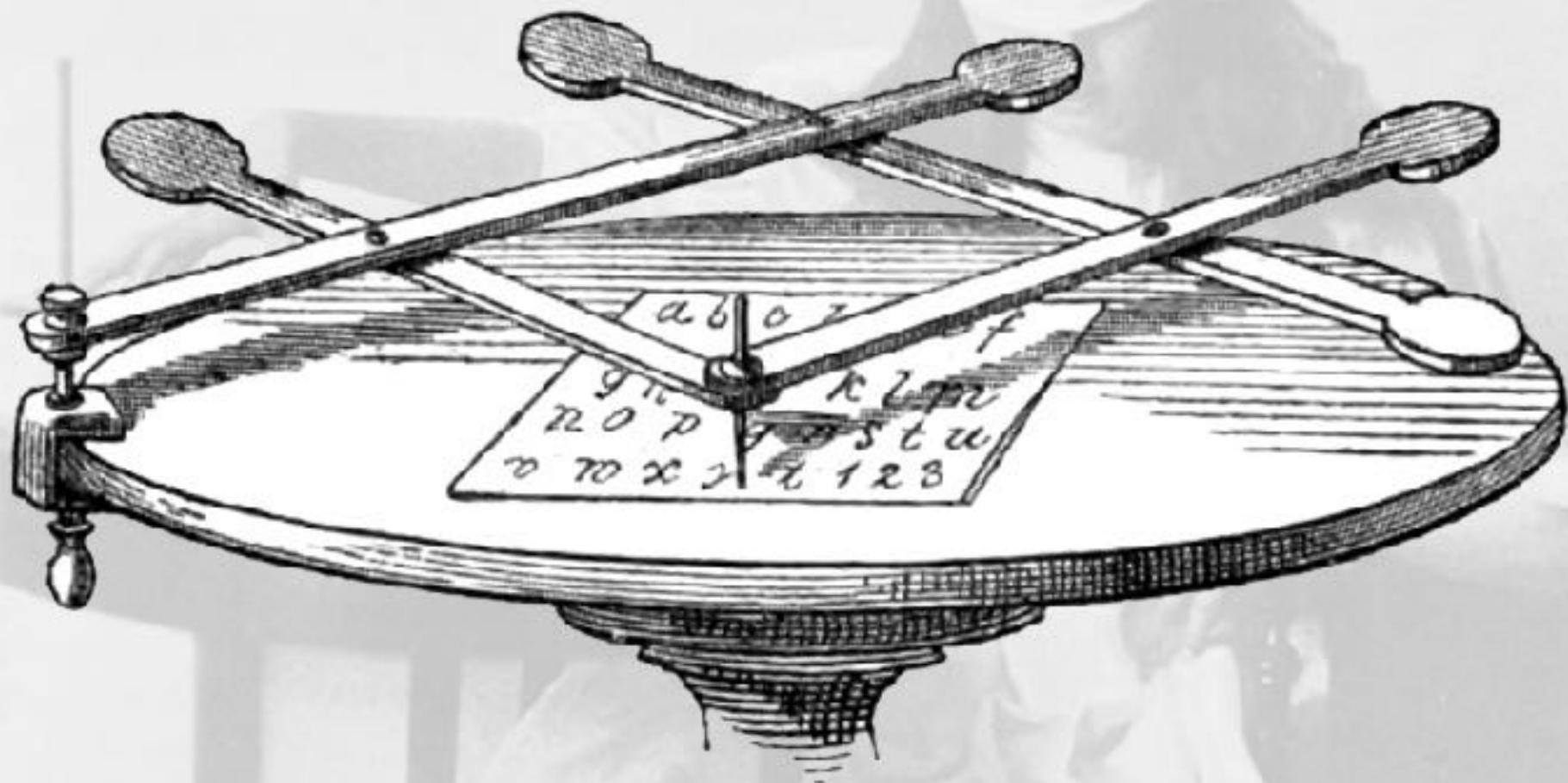

(from *Morgenblatt*, 5 February 1854)



"Der Spiritismus" Illustre Zeitung Leipzig, 1877

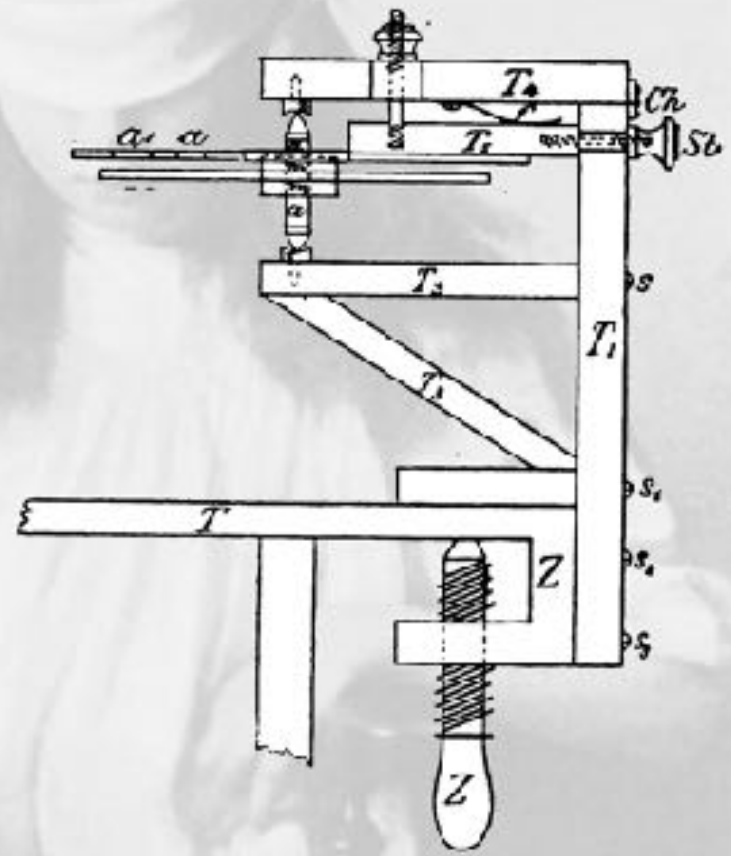
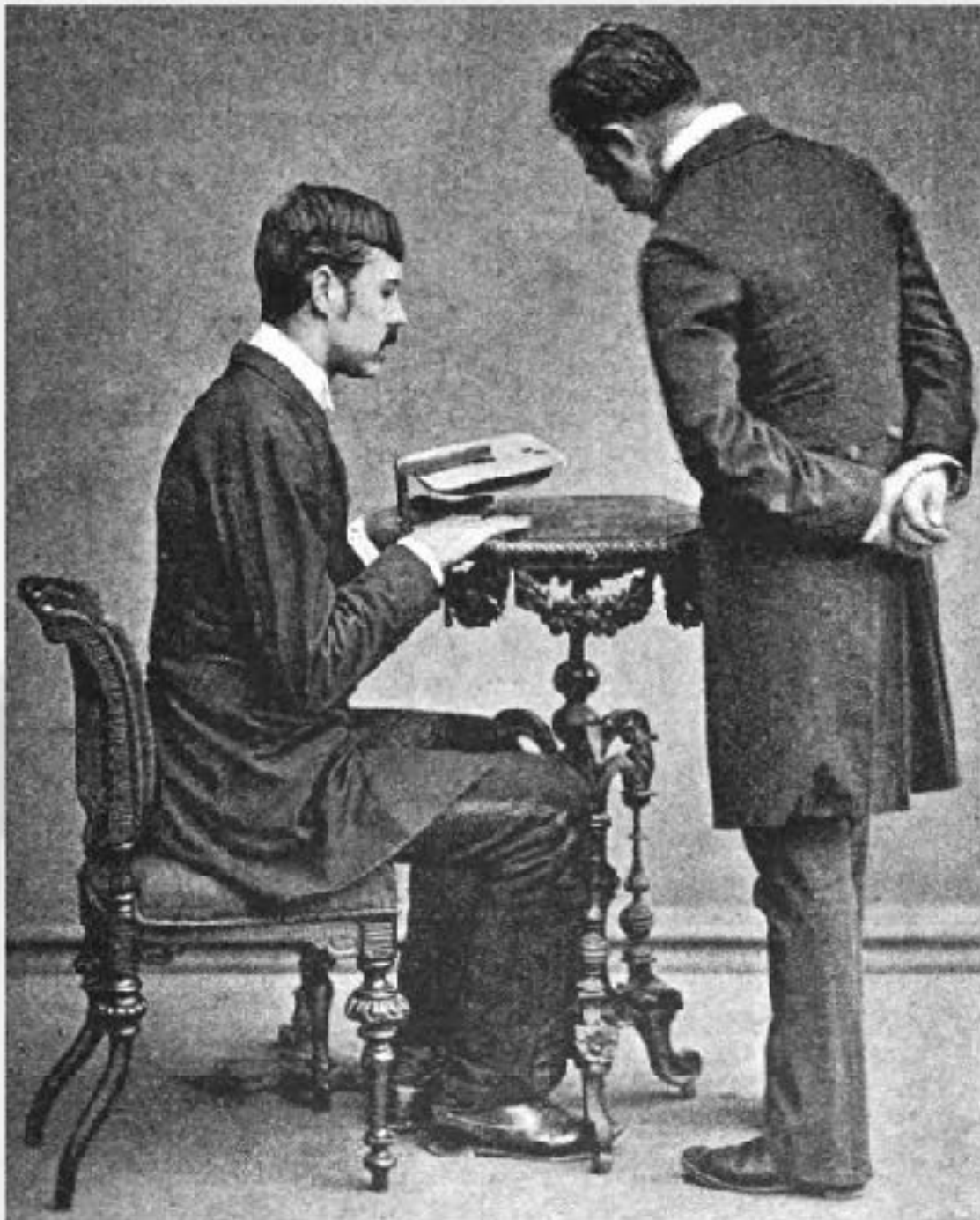

Hornung's
Emanulector

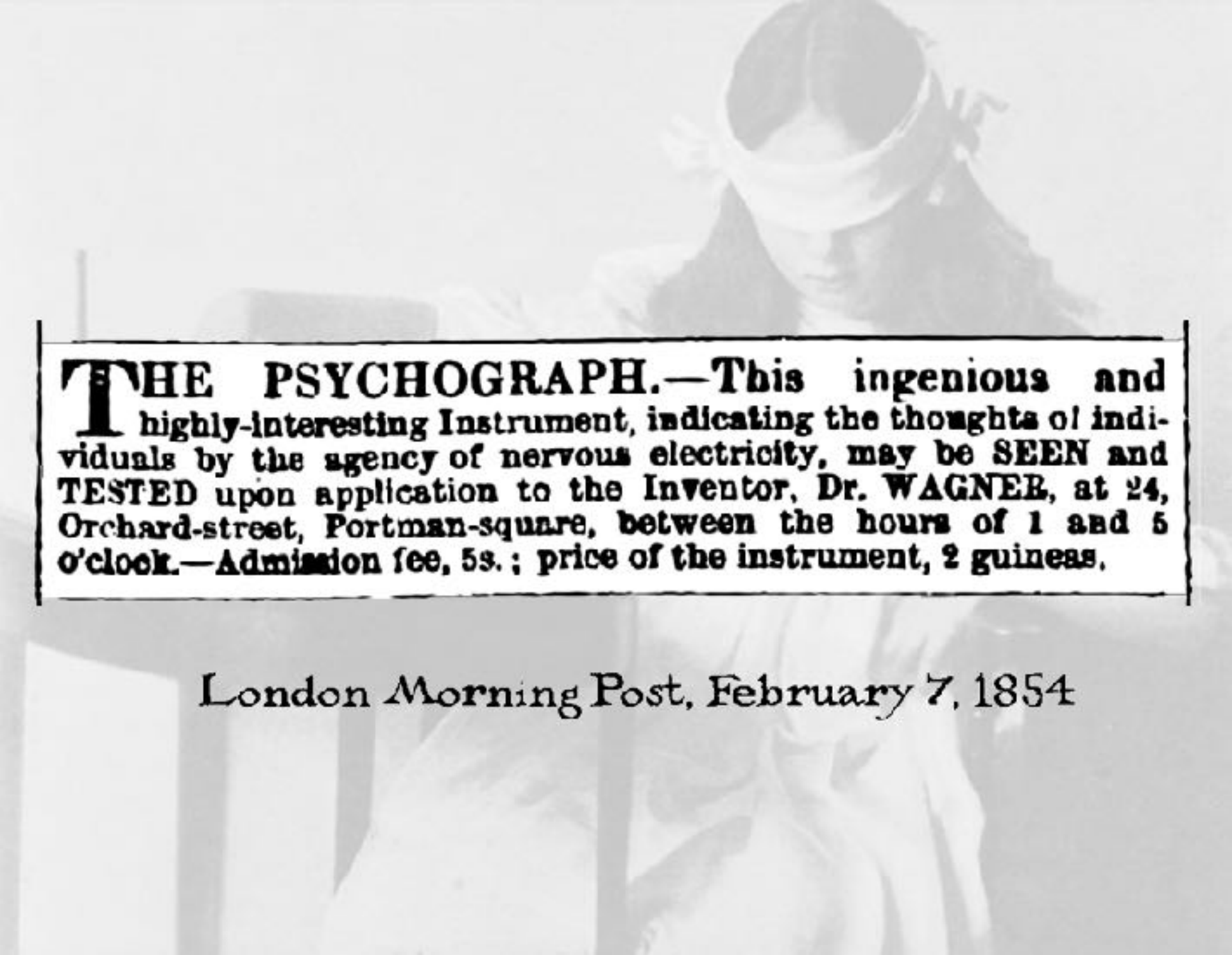

THE PSYCHOGRAPH.—This ingenious and highly-interesting Instrument, indicating the thoughts of individuals by the agency of nervous electricity, may be SEEN and TESTED upon application to the Inventor, Dr. WAGNER, at 24, Orchard-street, Portman-square, between the hours of 1 and 5 o'clock.—Admission fee, 5s. ; price of the instrument, 2 guineas.

London Morning Post, February 7, 1854

A SPIRITUAL MACHINE.

On the same day as our notice of M. Wagner's Thought Indicator was published, the *Scientific American* issued an article, headed as above, containing a description of a machine just invented by Mr. J. T. Pease, of Thompsonville, Connecticut, called a Spiritual Telegraph Dial. The apparatus is contrived with a dial-face, on which are marked the letters of the alphabet, the numerals, the words "yes" and "no," and other convenient signs. A moveable hand, or pointer, is fixed in the centre; "and when a ghost wants to communicate with its pupils and friends in the body, all that is requisite is, for it to give a gentle twitch to the pointer, and the revelation is accomplished." Mr. Pease states, "that with a good tipping medium to facilitate the movements of the pointer by agitating the table, letters will be indicated to the dial as fast as an amanuensis can write it down."



Isaac Pease Spiritual Telegraph Dial, 1853

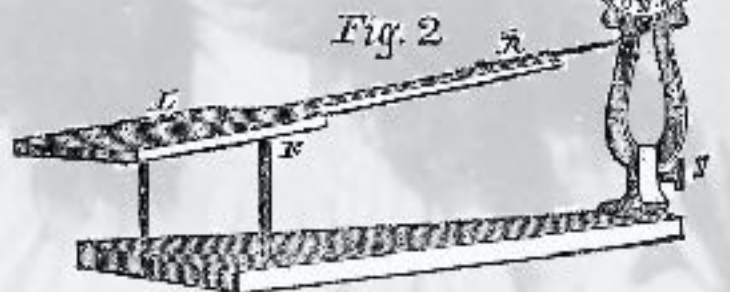
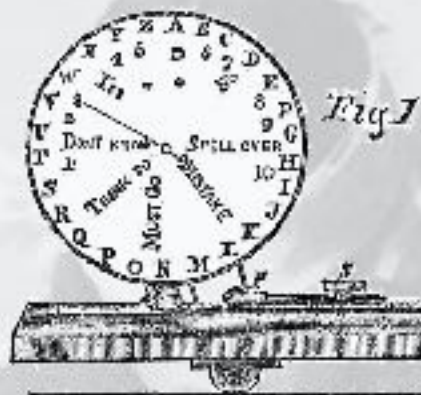

No. 4

Dr. Hare's "Spiritoscopes"

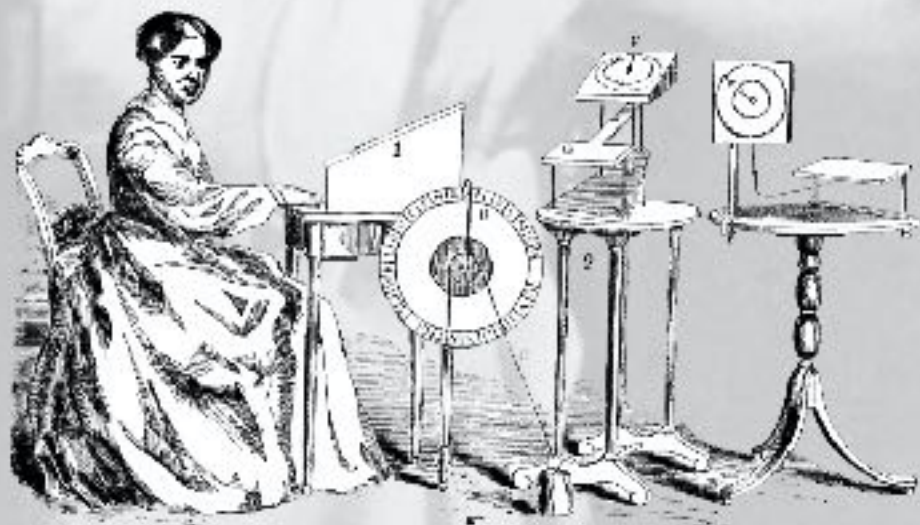
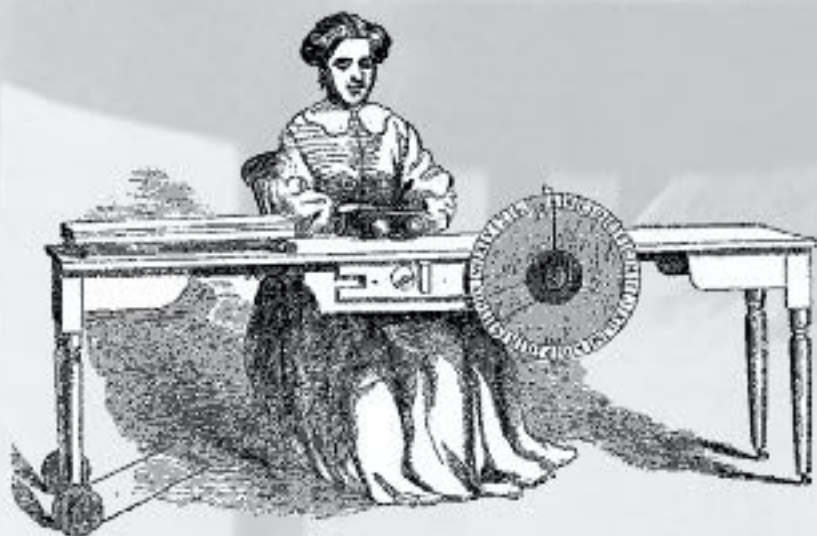

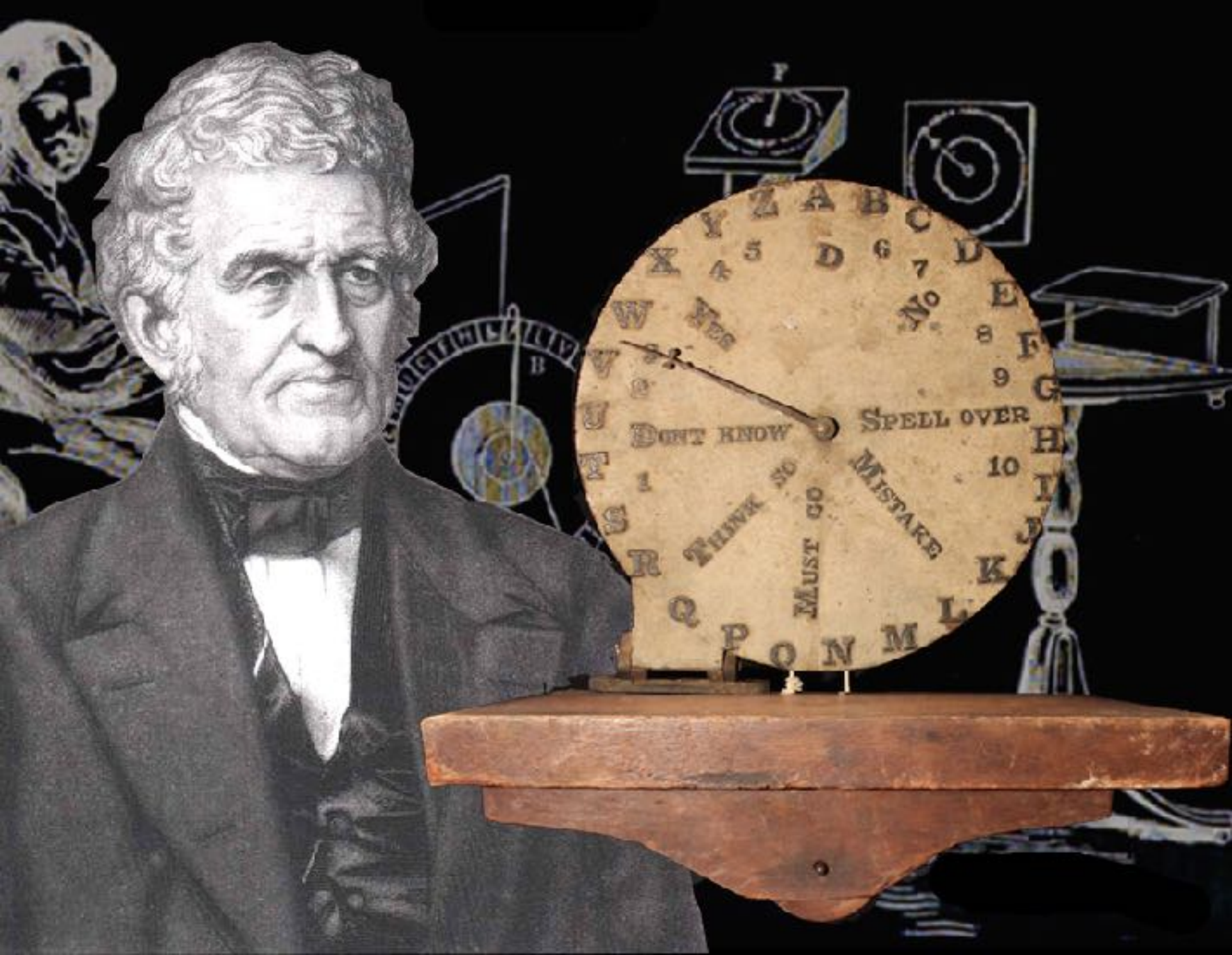

June 10, 1853

Paris, France



“Fetch the little basket from the next room;
fasten a pencil to it; place it upon a sheet of paper;
put your fingers on the edge of the basket.”



Mysterious Planchette



Robert Dale Owen



SPIRITUAL MANIFESTATIONS IN ATHENS CO., OHIO.

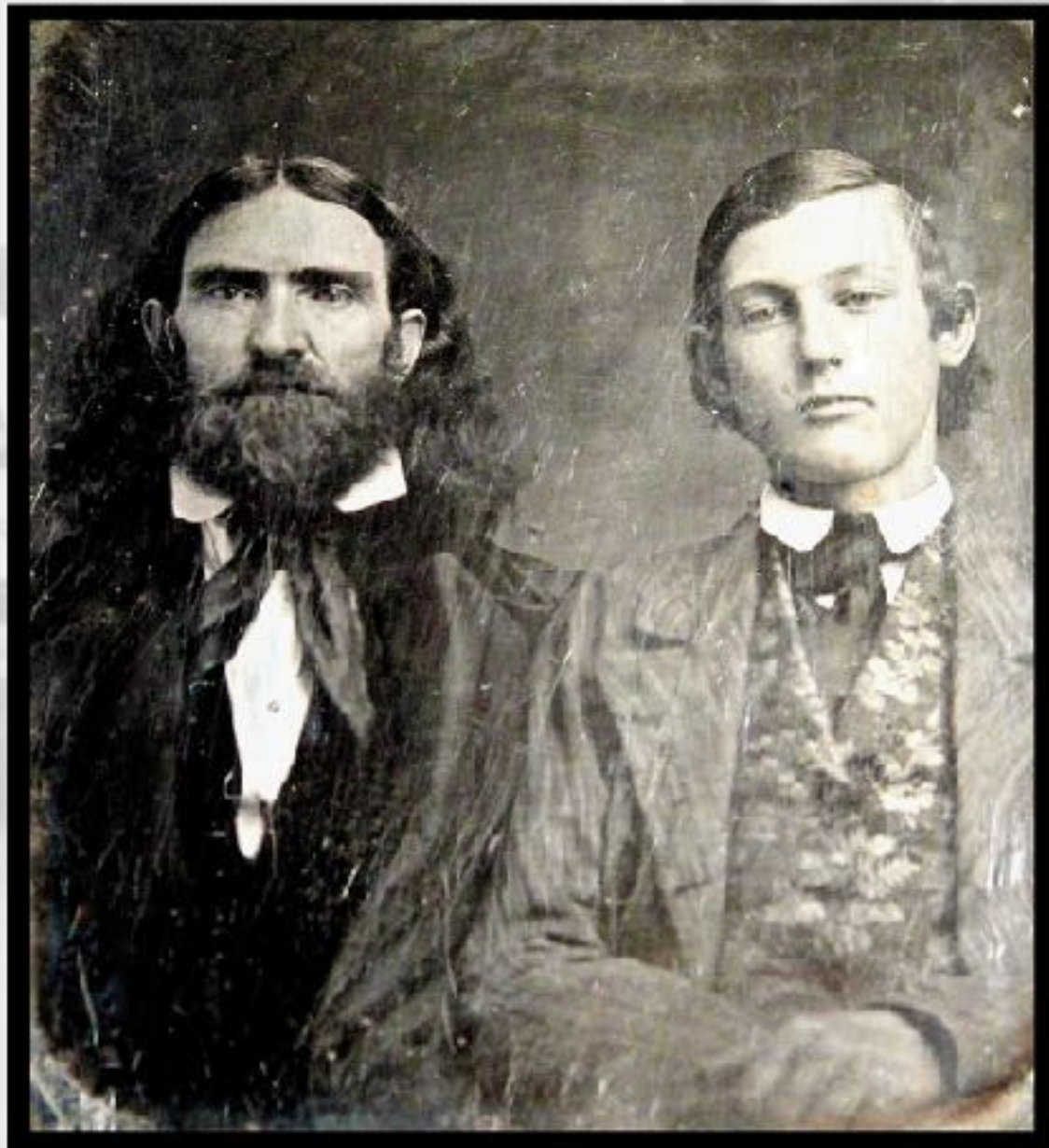

SPIRITUAL MACHINE.

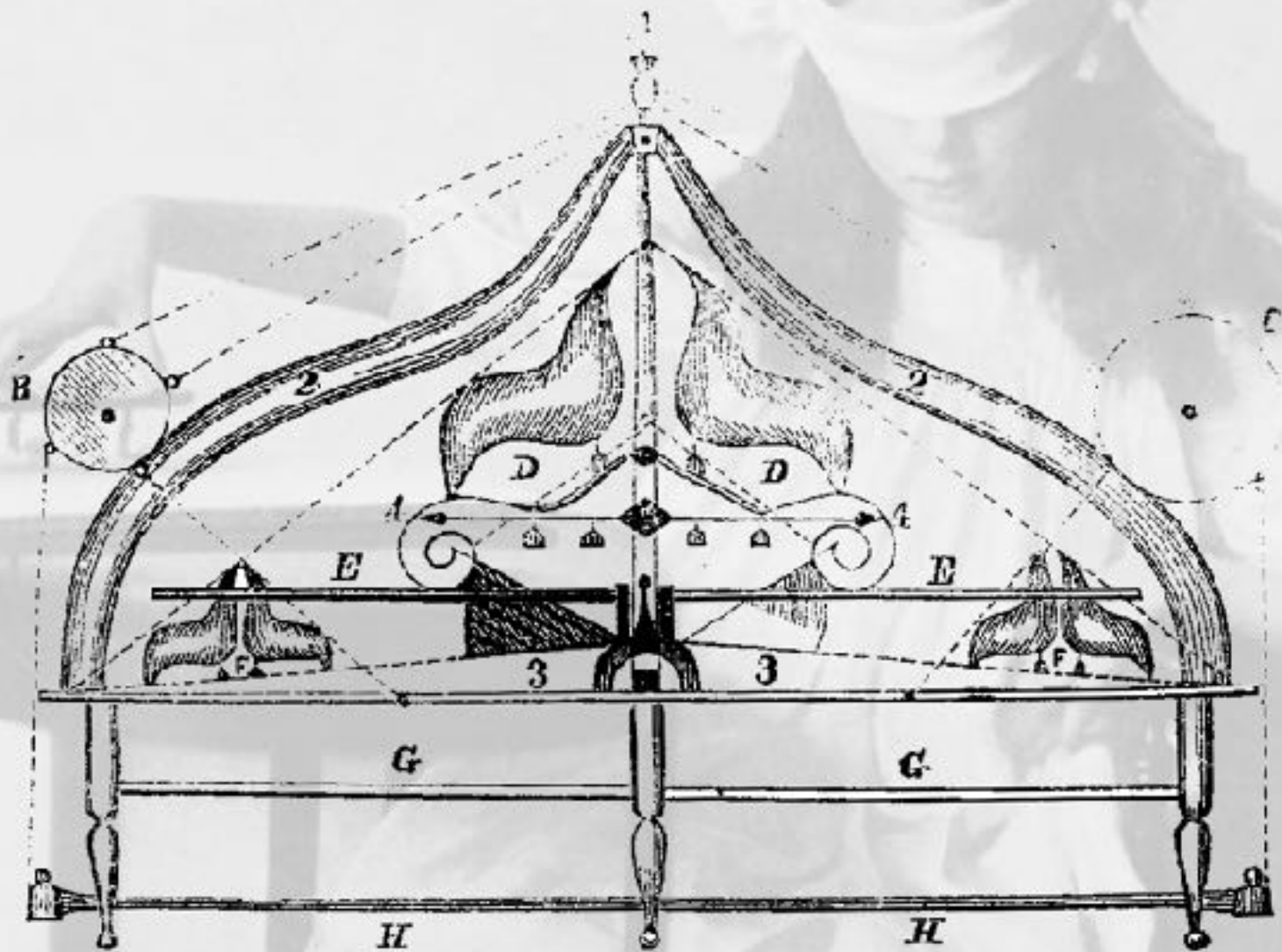



John Murray Spear

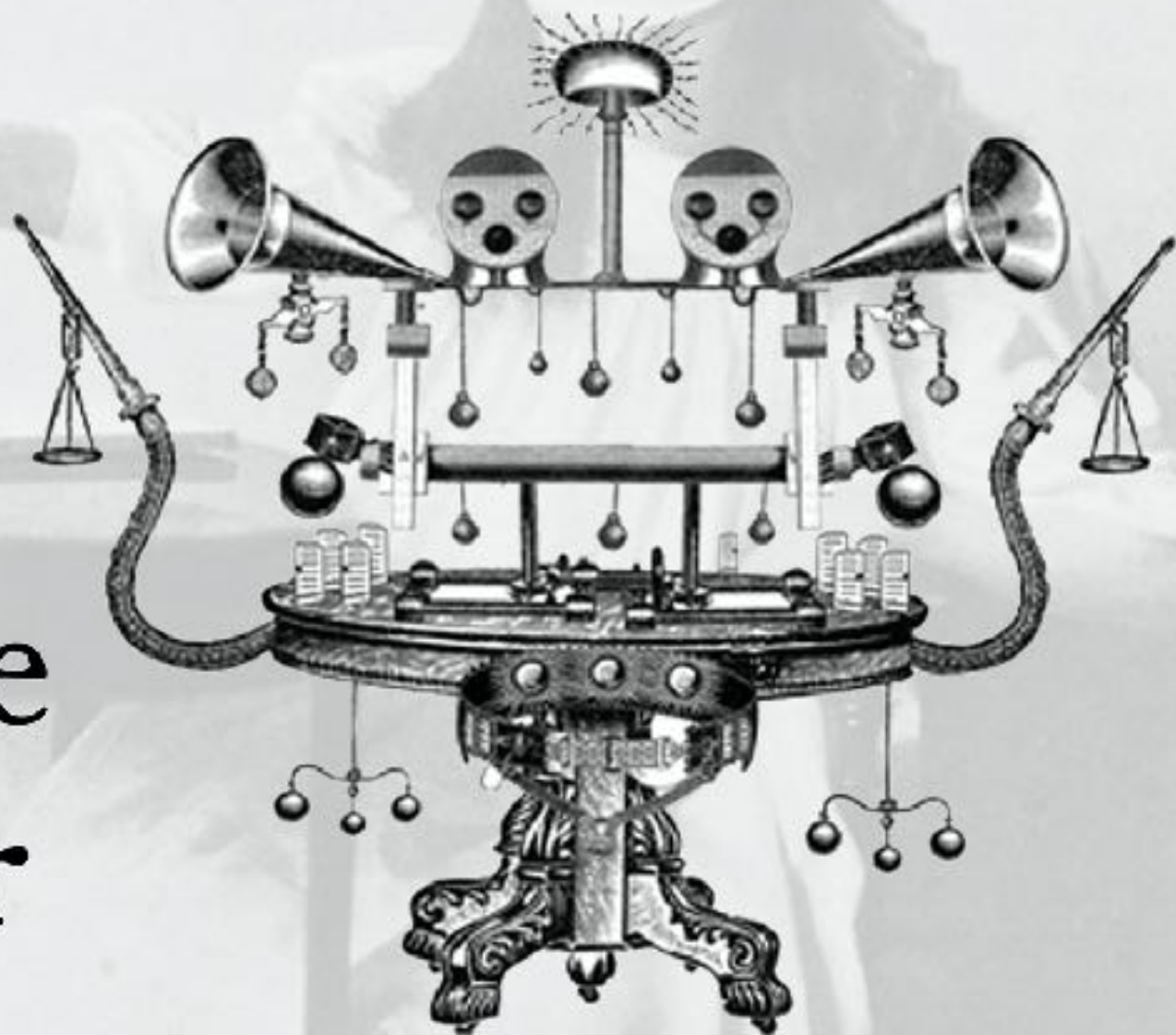

New
Motive
Power



**VOICES From the
SPIRIT WORLD**



**THROUGH ALUMINUM
TRUMPETS**

The ideal way to develop trumpet
mediumship is through earnest, sin-
cere work. This professional size
trumpet comes in four sections, 41
inches long with a five-inch bell open-
ing. Complete with luminous head,
only \$8.75, postpaid. Write Venture
Bookshop, P.O. Box 671, Evanston,
Ill.



Seance Trumpets



THE DAVENPORT BROTHERS'
PUBLIC CABINET SÉANCE.



NOW BEING HELD AT

THE QUEEN'S CONCERT ROOMS,
HANOVER SQUARE.

The Drawing is the Property of Messrs. Bates, Kilduff & Co., London.

The Davenport Brothers



MR. IRA DAVENPORT

MR. FAY

MR. COOPER

MR. W. DAVENPORT





Ectoplasm





18688

AMERICAN CIVIL WAR

750,000+ CASUALTIES





PLANCHETTE.*

TO THE EDITOR OF "ONCE A WEEK."

SIR,—Having read the article upon "Planchette" in your number for Oct. 26, I beg to inform you that I am desirous of procuring the machine, as sometimes in the winter evenings in the country we are in want of amusement. Would you kindly publish in the first convenient number of your periodical the address at which a "Planchette" can be procured? I have a family of sons and daughters, ranging in age from ten to twenty-three, and they keep my house continually full of people, who must be amused. The day is easy enough; but oh! the long evenings when we cannot dance!

Your obedient servant,
AN ANXIOUS MAMMA.

— Park, Yorkshire, Nov. 1.

[NOTE.—In reply to her inquiry, an "ANXIOUS MAMMA" will be glad to know that the "Mr. B." of the article to which she refers gave Messrs. Elliott, Brothers, the Mathematical Instrument Makers of No. 449, West Strand, close to Charing Cross, his American "Planchette" to copy, and that they supply them. We hear that the "Planchette" is made also and supplied by Mr. Thomas Welton, 13, Grafton Street, Fitzroy Square.—Ed. O. A. W.]

* See ante, p. 486.

October 26 1867

"Once a Week"



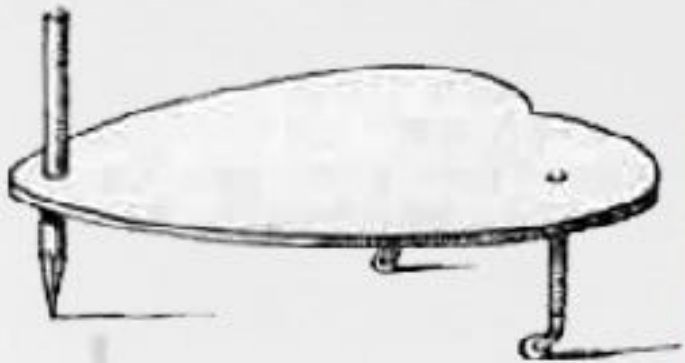



THE PRESS ON "PLANCHETTE"

From the Albany Evening Journal.
The Albany Evening Journal has published an account of the Planchette, and the following is a translation of the article. The Planchette is a new invention, and it is said to be the most perfect yet discovered. It is a small, portable, and easy to use, and it is said to be the most perfect yet discovered. It is a small, portable, and easy to use, and it is said to be the most perfect yet discovered. It is a small, portable, and easy to use, and it is said to be the most perfect yet discovered.

THE PRESS ON "PLANCHETTE"
The Albany Evening Journal has published an account of the Planchette, and the following is a translation of the article. The Planchette is a new invention, and it is said to be the most perfect yet discovered. It is a small, portable, and easy to use, and it is said to be the most perfect yet discovered. It is a small, portable, and easy to use, and it is said to be the most perfect yet discovered.

LATEST APPLIED FOR. PATENTED AND FOR SALE BY
KIRBY & CO., 633 BROADWAY, New York
A LIBERAL DISCOUNT TO THE TRADE.





CAUTION.

KIRBY'S IMPROVED PLANCHETTE.

The public and the trade are informed that imitations of our Planchette, of inferior make, are in the market, and are apt to mislead the public. None are genuine unless stamped with our name and address.

WE NOW MAKE

- No. 1, a SUPERIOR PLANCHETTE, for..... \$1.50
- No. 2, with Pentagraph Wheels, highly polished..... \$3.00
- No. 3, India Rubber..... \$4.00
- No. 4, Plate Glass..... \$5.00

Buy none but Kirby's, and you will get a Planchette that will work.

KIRBY & CO.,
633 Broadway, New York.

Planchette made its appearance in Portland last March, and Cyrus H. Farley manufactured quite a number which he sold at the Cretan fair in Boston. He attempted to awaken an interest in the subject in the mind of Boston people, but everybody laughed at him. He then went to New York and enlisted the efforts of a Mr Kirby, and since that time Farley and Kirby have manufactured over 34,000 planchettes. Mr Cottrell, the manager of the "Boston planchette" business, got his idea from them, being formerly their agent.





Dedicated to

Kirby & Co. 633 Broadway, N.Y.

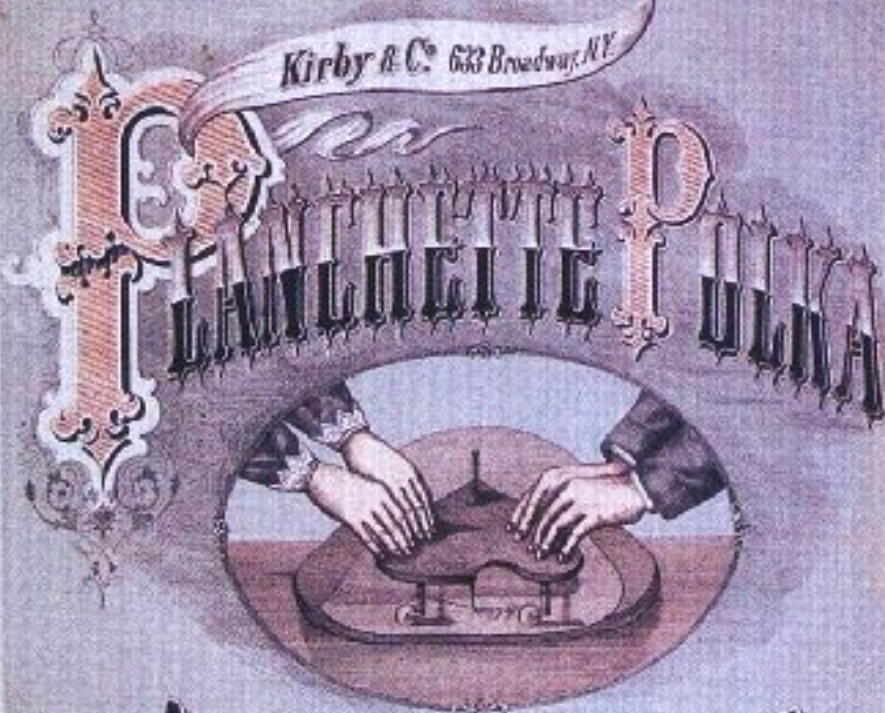

COMPOSED BY
AUG. LA MOTTE

CINCINATI, O.

Published by C. Y. FONDA, 72 West Fourth St.



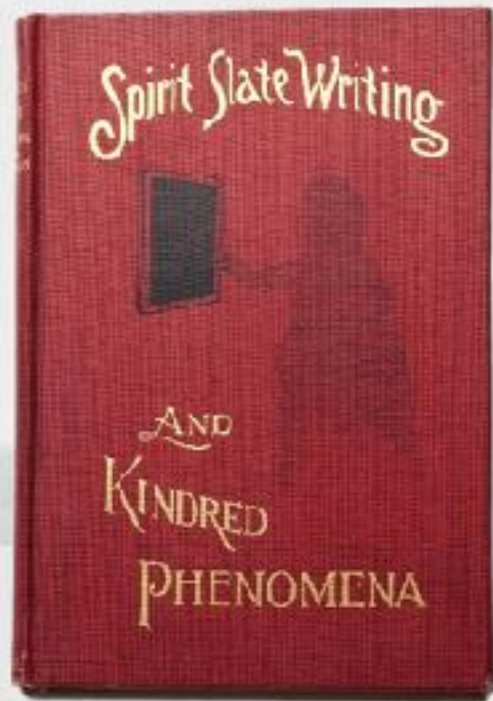

Henry Slade



Pierre L.O.A. Keeler

Spirit Slates

The attitude of con-
victed believers in Spanish
life towards the blind
leaders of the blindly
doctrinaire in Spanish
matters should be that
of the Deers to those
of the dark as
fall of loungers and
Hendricks at one

Planchette Writing

"It will spell out words as fast as an ordinary writer can take them down. I have tried all the alphabetic methods, from calling over the alphabet, discs, and pointers, &c., and planchette and other experiments for facilitating communications, and have found the one I am about to describe a great improvement, and both simple and inexpensive."

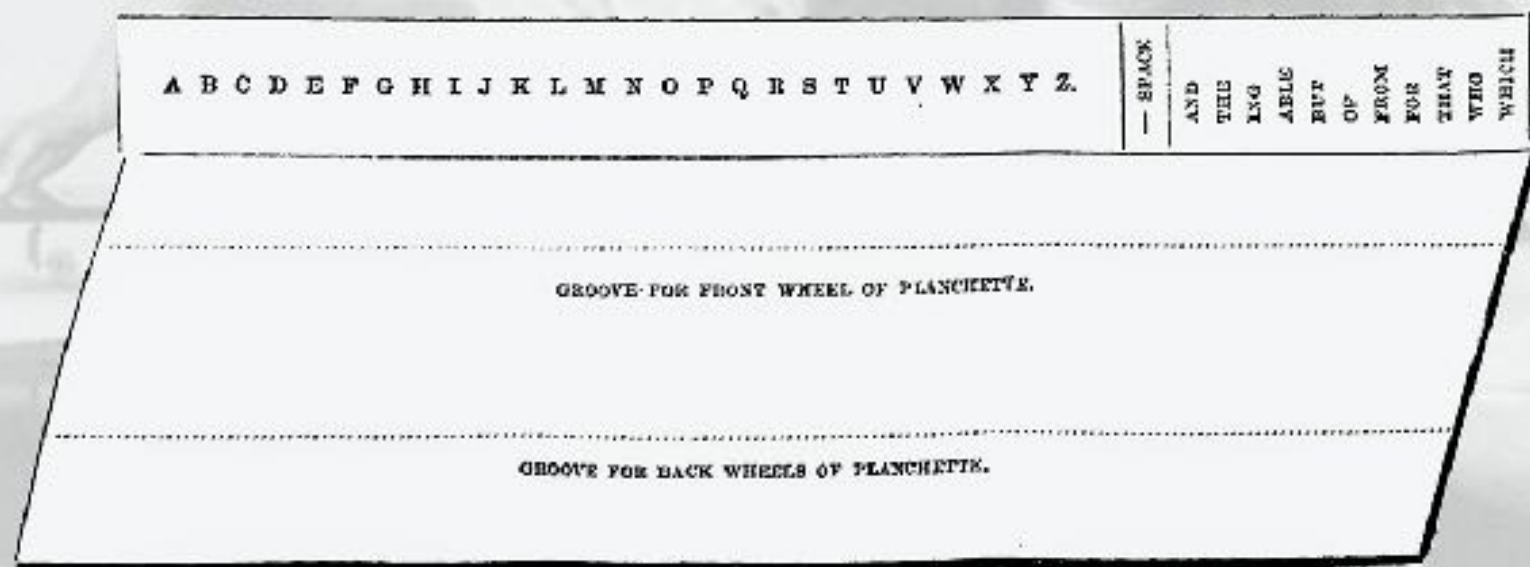

The Bewley Indicator, 1871

THE TWO DISCOVERIES;

OR,
KEY

TO

PINE'S SPIRITUAL TELEGRAPH.

*This Key not only Unlocks the Abstruse Labyrinths of
Mathematical Science, but enables every Person
who values the privilege, to Converse as
freely with Friends in Spirit-Life
as when they were on Earth.*

CONTAINING

A SERIES OF COMMUNICATIONS,

OF THE MOST INTENSE INTEREST BY THIS NEW INVENTION,
WITH AN

ENGRAVING OF THE INSTRUMENT.

By CLEMENT PINE.

LONDON:

E. W. ALLEN, 11 AVE MARIA LANE, AND STATIONERS' HALL
COURT, E.C.

ALSO PUBLISHED BY THE AUTHOR AT BRIDGWATER;

And to be had of all Booksellers, Price 1s., Postage 2d.

[Stereotyped, and Copyright secured.]

1874.

H. Nisbet, Printer,

219 George Street, Glasgow

Pine's Spiritual Telegraph

1874

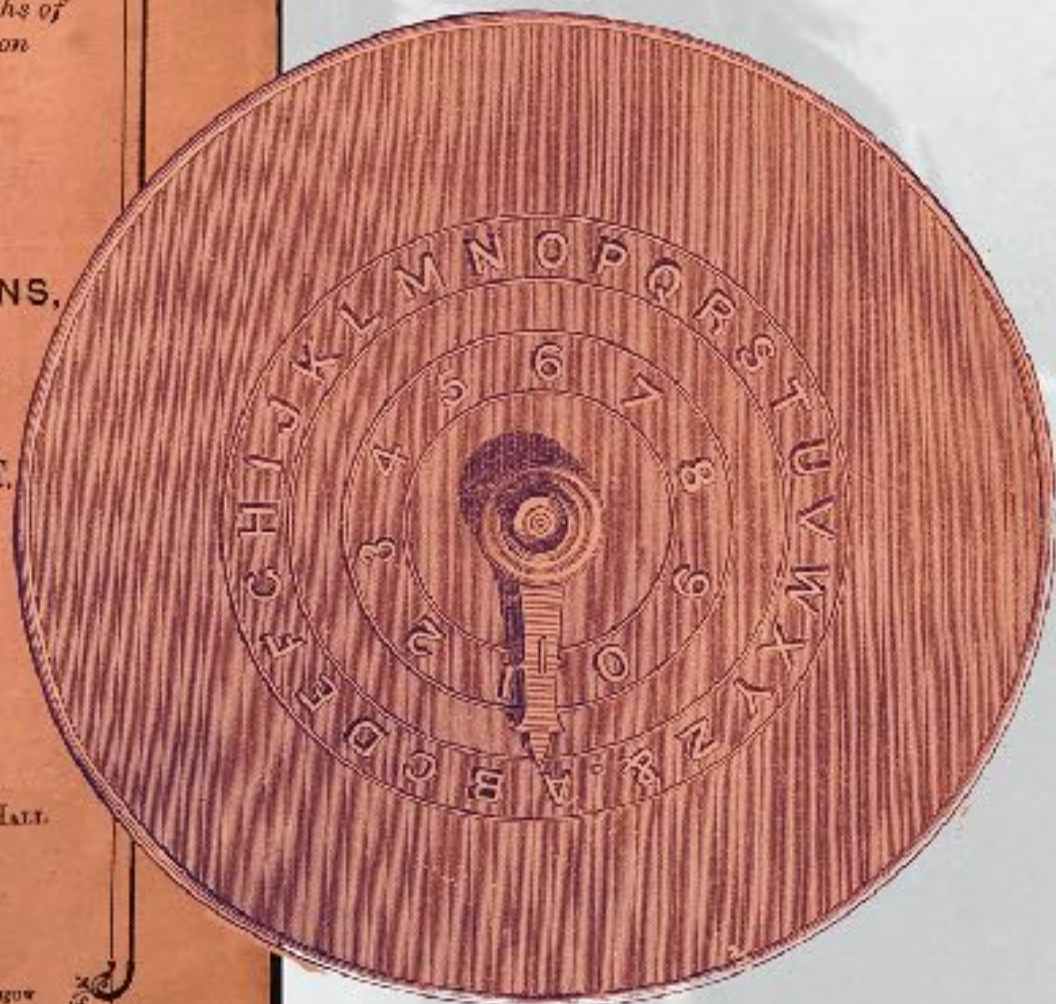

"But there has been discovered, by my wife, a method which will enable many persons to get manifestations who could not get tippings of the table; and for those who require tippings of the table to point out the letters when the alphabet is called, a method here is offered that will facilitate operations greatly."

A	G			N	U
B	H			O	V
C	I			P	W
no	J	(_____)	Q yes
D	K			R	X
E	L			S	Y
F	M			T	Z

The "L.K." Table, 1876



Hudson Tuttle

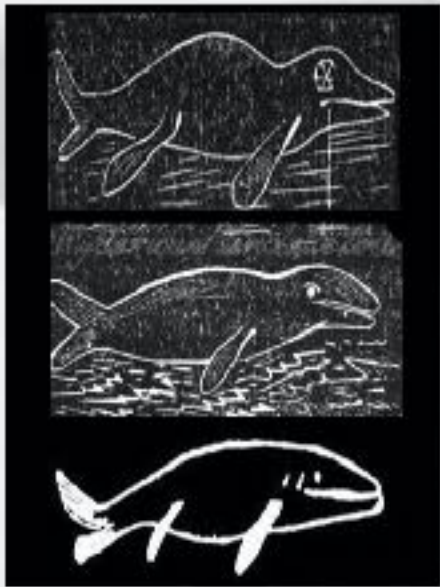

Tuttle Psychograph, 1880s



1886

Ohio, 1886

YES. NO.
A B C D E F G H I J K L M N O P Q R
S T U V W X Y Z &.,
1 2 3 4 5 6 7 8 9 0

GOOD-EVE.

GOOD-NIGHT.

Yes.	No.
A B C D E F G H I J K L M N	
O P Q R S T U V W X Y Z &.,	
1 2 3 4 5 6 7 8 9 0	
Good Eve.	Good Night.



The "New Planchette"

THE TALKING BOARD.

Patented Feb. 10, 1891.

Fig. 1.



Charles F. Keenwood

1891

Fig. 2.

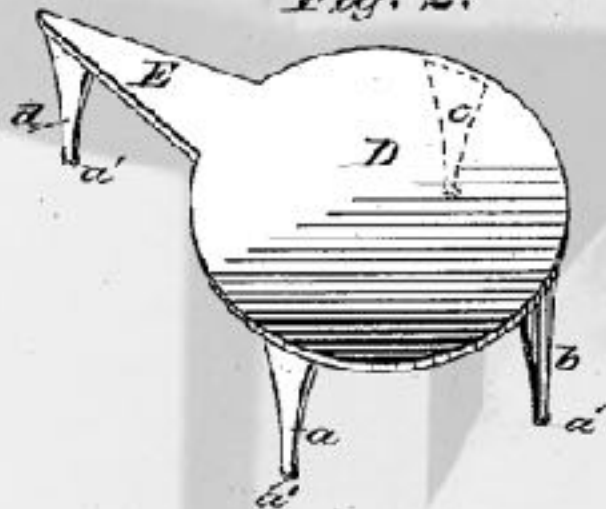

✂ ✂
 VoLô
 1 ABCDEFG 6
 2 HIJKLM 7
 (LEAR) 3 NOPQR 8 RAIN
 4 STUV 9
 5 W
 YES
 F

A B C D E F G
 H I J K L M N
 O P Q R S T U
 V W X Y Z
 6 7 8 9

A B C D E F G H I J K L M
 N O P Q R S T U V W X Y Z
 1 2 3 4 5 6 7 8 9 0
 BEST

A B C D E F G H I J K L M N
 O P Q R S T U V W X Y Z
 1 2 3 4 5 6 7 8 9 0

A B C D E F G H I J K L M N
 O P Q R S T U V W X Y Z
 1 2 3 4 5 6 7 8 9 0 No
 "The Wireless Messenger"

BECAUSE SHALL YES YOU NEXT GOOD
 COME MURDER AND WELL SUCCESS
 ADIEU
 HOROSCOPE TAROT
 WEEK DAYS SAT. THU. FRI. SUN.
 TRI. WED. MON.



1,418,686.

Patented Jan. 6, 1923.
 248677-1-23 11



N. E. GOLDBERG.

WHEEL ALLOW.
 APPLICATION FILED JUNE 1, 1921.

1,366,174.

Patented Jan. 18, 1921.

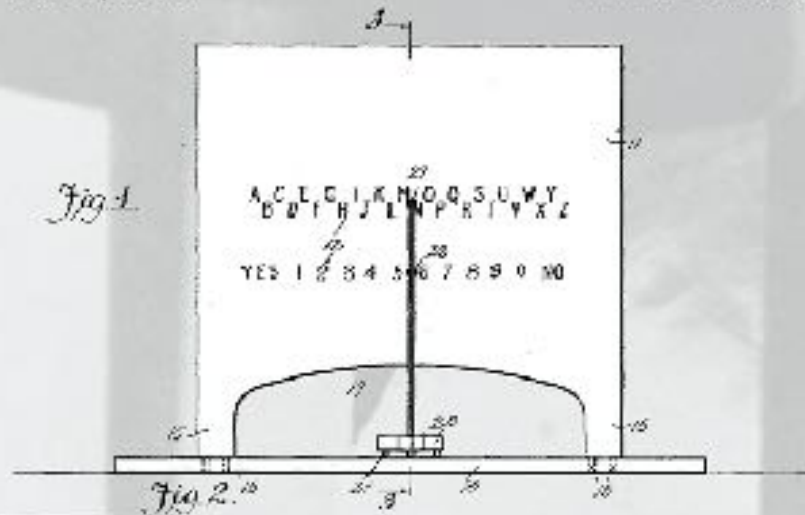
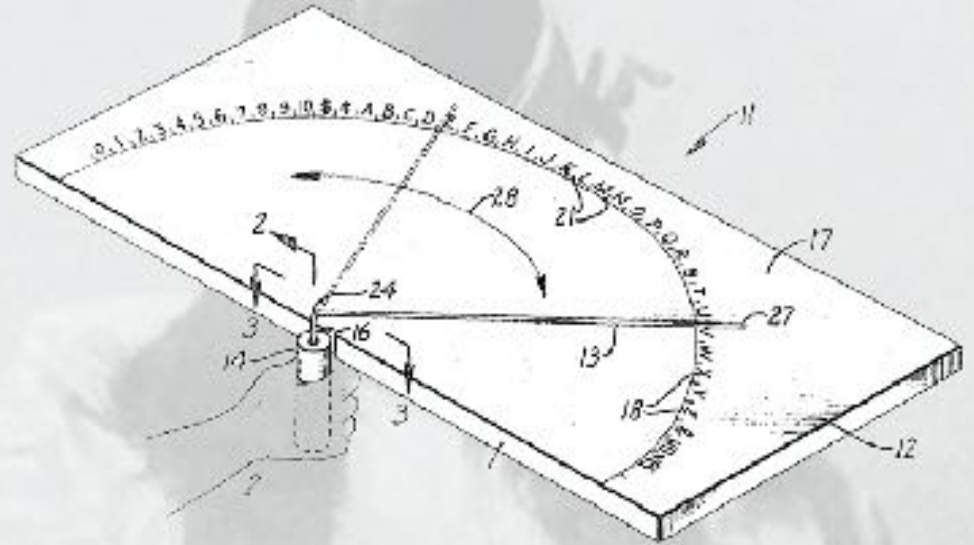

Fig. 2.



B. SULLIVAN.
 NO. 1000 BOND.
 APPLIC. FILED MAR. 25, 1918.

1,277,162.

Patented Aug. 27, 1918.



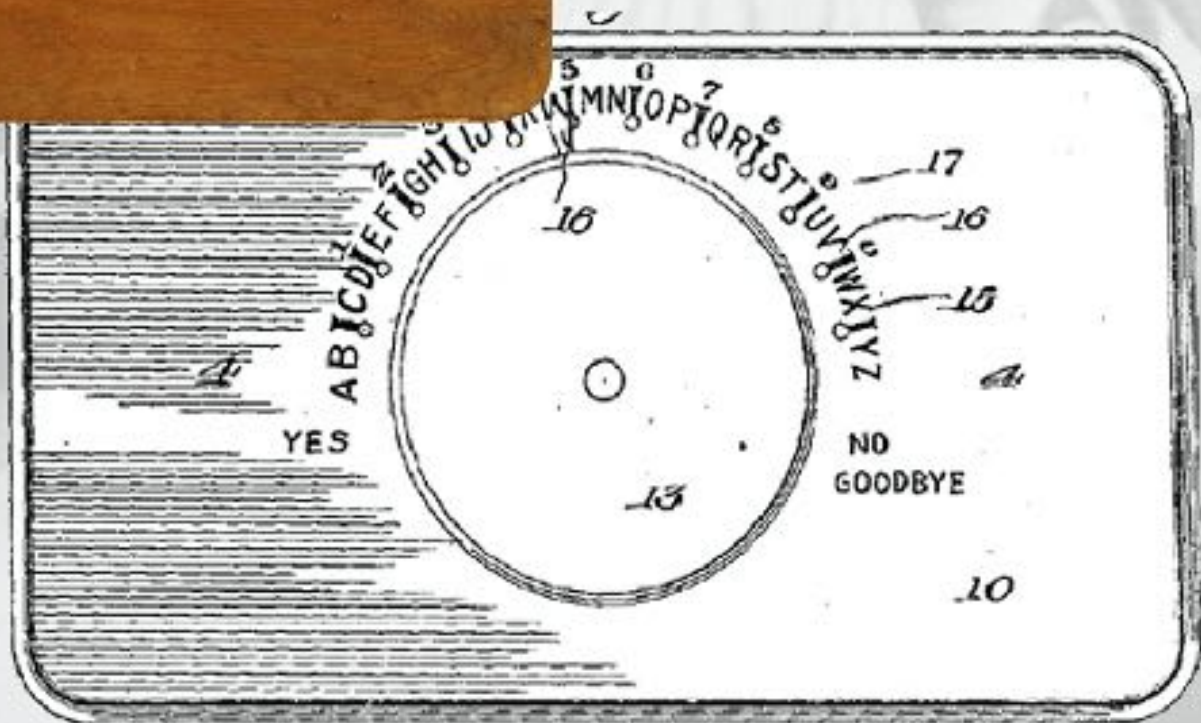

1891

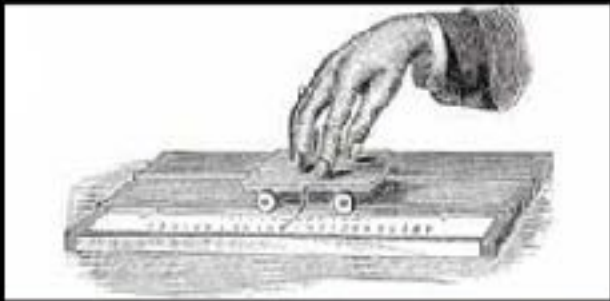

1910

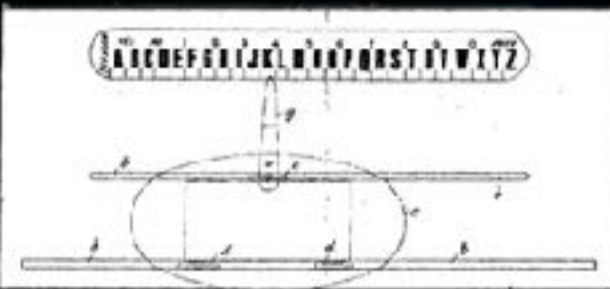

1918

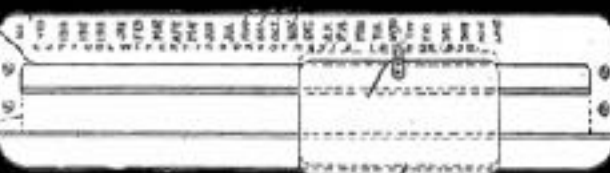

1921

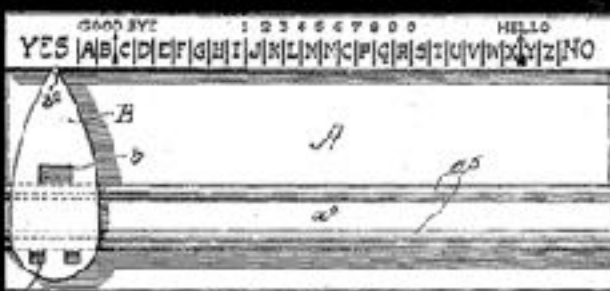

1950



“Slide” Dials



Entered June 6, 1922
 2,487,184







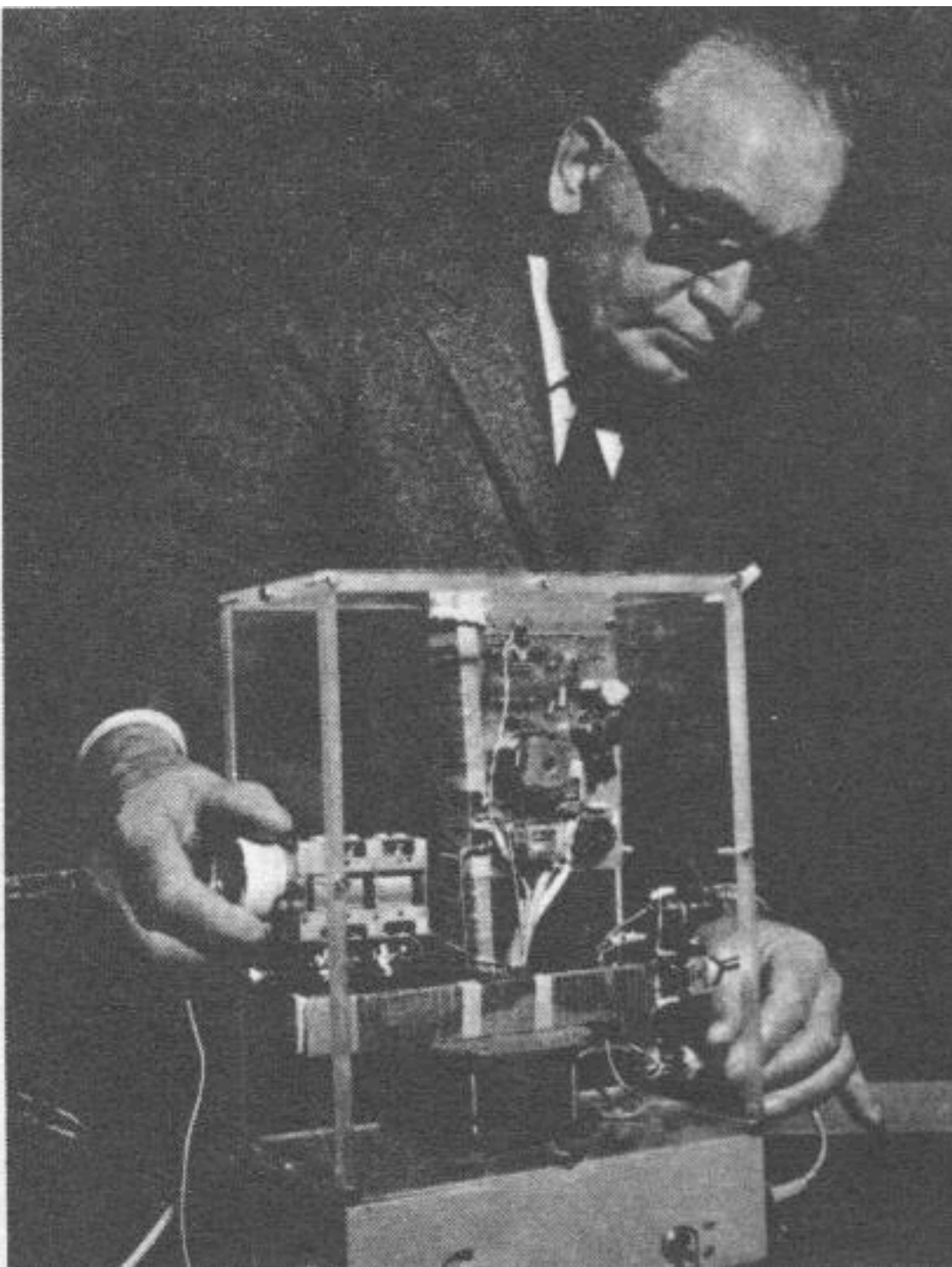

"I have been at work for some time building an apparatus to see if it is possible for personalities which have left this earth to communicate with us." –Thomas Edison







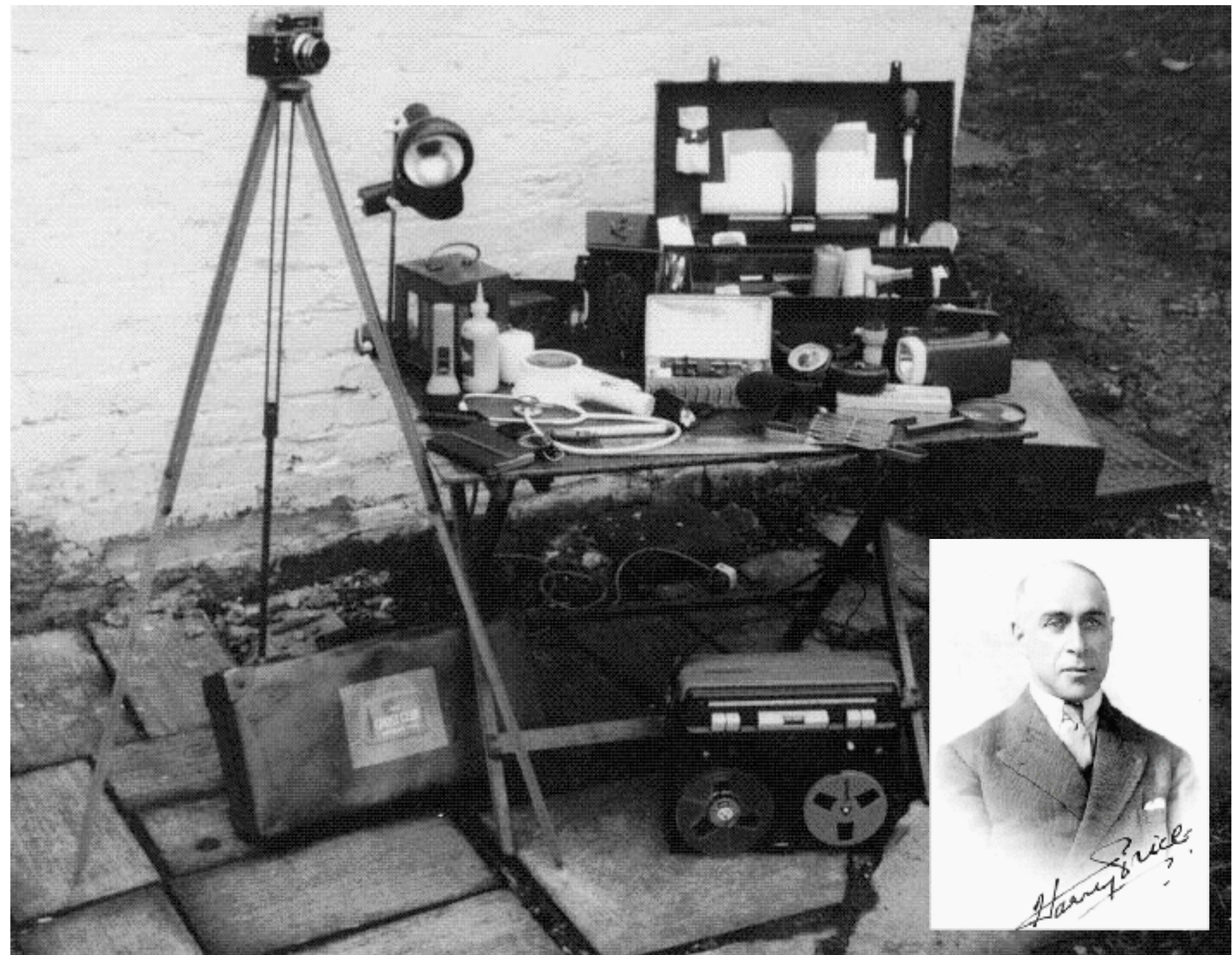

Ghost Box



Camera



Video Camera..

Top Tools Needed for a Ghost Hunt..



EMF Detector

Digital Recorder



Thermal Scanner



2 way radios



Torch





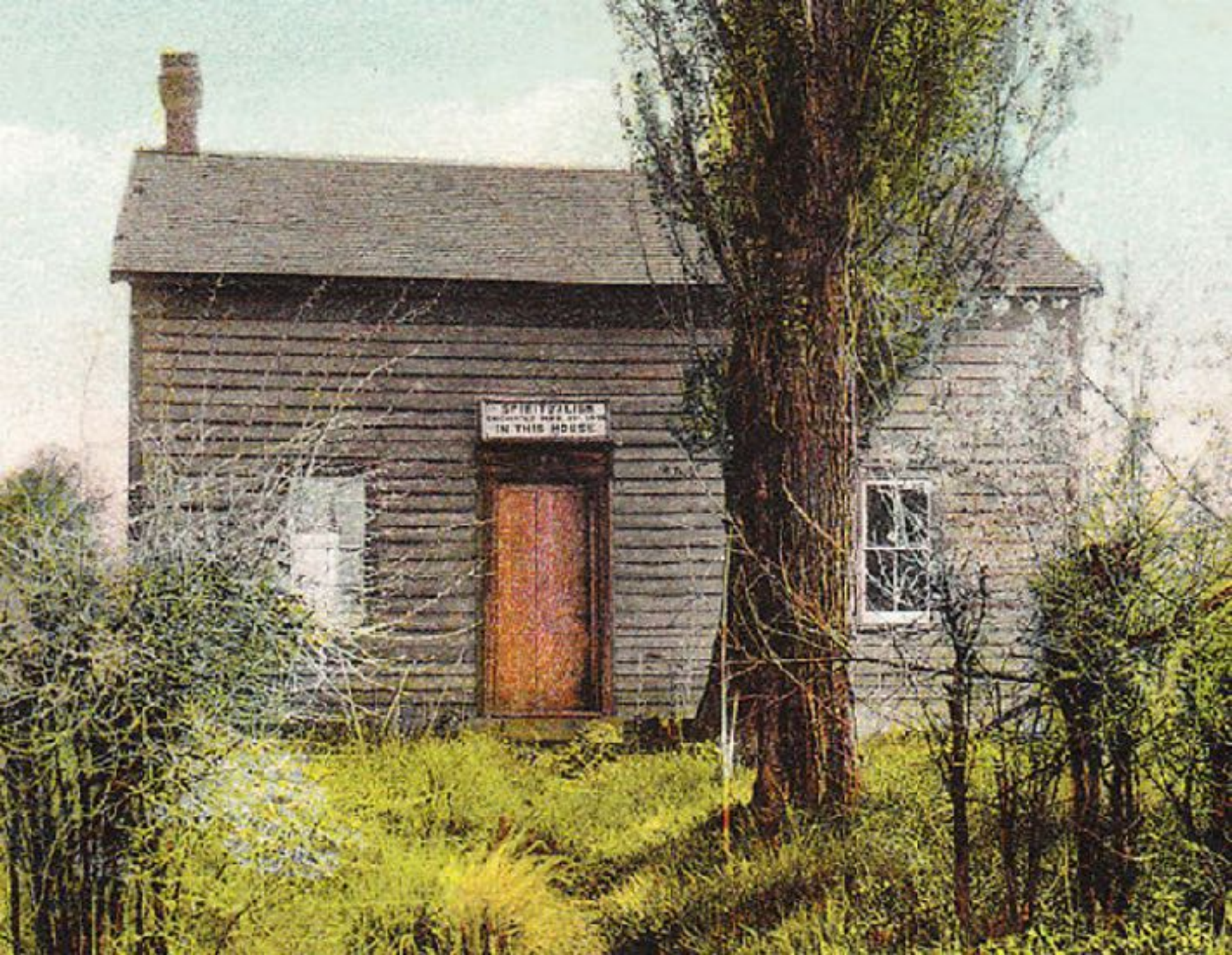

SPIRITUALISM
ENCHANTED MARK OF THE
IN THIS HOUSE



MysteriousPlanchette.com

